



# TROULLIDES

Hotel Bathroom Scale

Galilaiou 1 Latsia, 2233 Nisosia

Tel.: 22 488515, 22 483643 Fax: 22 488515

Email: [info@troullides.com.cy](mailto:info@troullides.com.cy), [taster@cytanet.com.cy](mailto:taster@cytanet.com.cy) <http://www.troullides.com.cy>



## Hotel Bathroom Scale Battery Free Model: HS-D3A

- Battery-Free
- 4-Sensor Technology for Precise Weighing
- Capacity: 180Kg / 396lb
- LCD Size: 81x42mm
- Division: 100g
- Product Size: 28x28x3cm
- Unit: Kg / LB
- Power: Say Goodbye to Battery
- Low Battery (LO) and Overload Indication (Err)
- N.W.: 1.5Kg
- G.W.: 1.69Kg
- Carton Size: 31.5x28.5x31.5cm
- Pcs/Carton: 5pcs / Carton
- Power Supply: Step On to Power

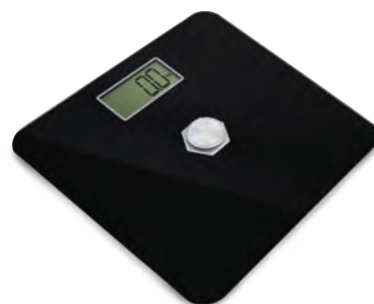

## Hotel Digital Bathroom Scale Full Glass Model: GL-FD205

- Full Glass Platform
- Equipped with 4 High Precision Sensors System
- Capacity: 180Kg
- Graduation: 0.1Kg
- LED Display, Size: 80x30mm
- Automatic Switch On/Off
- Units: Kg
- Low Battery / Overload Indication
- Battery: 3x1.5V AAA
- Dimensions: 300x300x6mm

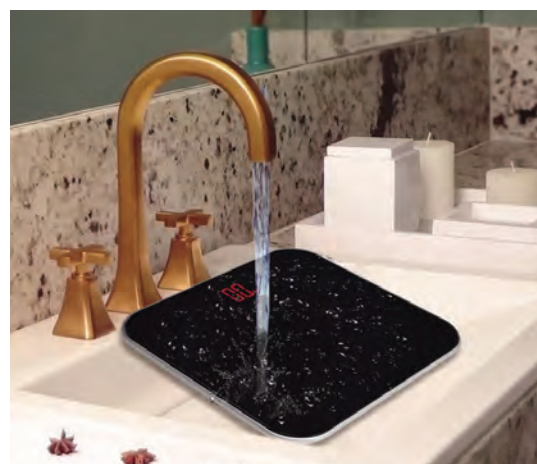



## Hotel Digital Bathroom Scale Tempered Glass Model: GL-D1102

- Tempered Glass Platform
- Equipped with High Precision Strain
- Gauge Sensors System
- LCD Display, Size: 61x25mm
- Low Battery / Overload Indication
- Automatic Zero Resting
- Material: Tempered Glass, ABS
- Division: 100g
- Max Weight: 180Kgs
- Dimensions: 28x28x2.3cm

## Hotel Digital Bathroom Scale Tempered Glass Model: HS-1102

- Tempered Glass Platform
- Equipped with High Precision Strain Sensor System
- Relative Humidity:  $\leq 95\%$ , Using Temperature:  $-40^{\circ}\text{C} - 85^{\circ}\text{C}$
- LCD Display, Size: 61x25mm Without Backlight
- Low Battery / Overload Indication
- Automatic Zero Resting
- Material: Tempered Glass, ABS
- Division: 100g
- Max Weight: 180Kgs
- Dimensions: 30x30x2.3cm

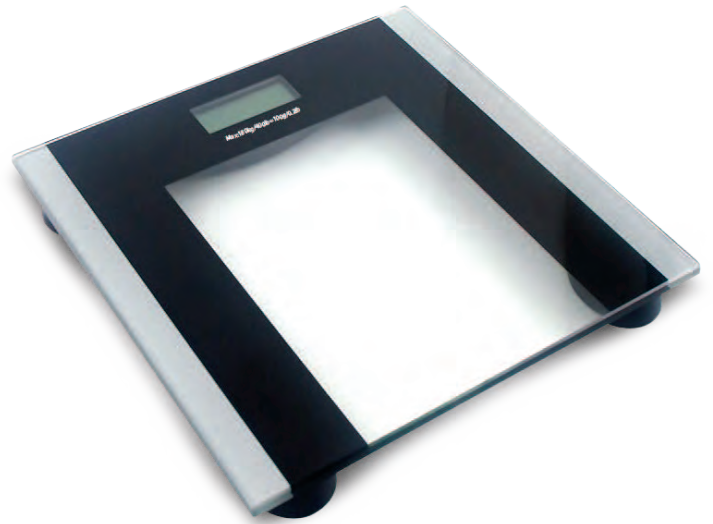

## Hotel Digital Bathroom Scale Tempered Glass with Stainless Steel Model: GL-D1A-S

- With 6mm Tempered Glass with S/S Platform
- Blue Backlight
- Equipped with High Precision Strain Sensor System
- Relative Humidity:  $\leq 95\%$ , Using Temperature:  $-40^{\circ}\text{C} - 85^{\circ}\text{C}$
- LCD Display, Size: 73x33mm With Backlight
- Low Battery / Overload Indication
- Automatic Zero Resting
- Material: Tempered Glass, Stainless Steel, ABS
- Unit: Kg / lb / st
- Division: 100g
- Max Weight: 180Kgs / 396LB
- Power Source: 2x1.5V AAA Batteries (not included)
- Dimensions: 30x30x2.3cm



## Hotel Digital Bathroom Scale Tempered Glass

Model: GL-D1M

- Material: Tempered Glass, ABS Plastic
- With 6mm Tempered Glass Platform
- Digits LCD Display
- LCD Size: 73x33mm with Backlight
- Automatic Zero Resting & Automatic Switch Off
- Low Battery / Overload Indication
- Equipped with High Precision Strain Gauge Sensor System
- Relative Humidity:  $\leq 95\%$ , Using Temperature:  $-40^{\circ}\text{C}$ - $85^{\circ}\text{C}$
- Power Source: 2x1.5V AAA Batteries (not included)
- Division: 100g
- Max Weight: 180Kg
- Dimension: 33x3.5cm



## Hotel Mechanical Bathroom Scale Tempered Glass

Model: GL-D1102-1

- Dimension: 35.5x35.5x6.5cm
- Mechanical Bathroom Scale
- 8mm Tempered Glass Platform
- Equipped with High Precision Strain Gauge Sensor System
- Each with Gift Box
- $\leq 95\%$ , Using Temperature:  $-40^{\circ}\text{C}$ - $85^{\circ}\text{C}$
- Shape: Round Maximum
- Load: 120Kg





# TROULLIDES

Hotel Door Lock

Galilaiou 1 Latsia, 2233 Nisolia

Tel.: 22 488515, 22 483643 Fax: 22 488515

Email: [info@troullides.com.cy](mailto:info@troullides.com.cy), [taster@cytanet.com.cy](mailto:taster@cytanet.com.cy) <http://www.troullides.com.cy>



Silver



Golden



Black

## Hotel Smart Door Lock

### Model: LD-510

- Material: Stainless Steel
- Frame Color: Silver
- Technology: Employ Electromagnetic Wave Induction Technology, being more Maneuverable.
- Applicable Card: T5577 Mifare One Em4305 ID Card
- Power Supply: 4 AA Alkaline Batteries
- Static Power Consumption: <math><10 \mu\text{A}</math>
- Dynamic Power Consumption: About 200mA
- Low Voltage Prompt: 4.8V
- Sensing Distance: 3-5cm
- Applicable Temperature:  $-20\text{--}50^{\circ}\text{C}$
- Relative Humidity: 15-85% (Non-Condensing)
- Anti-Static:  $>15.000\text{V}$
- It Ensures the Information won't be Lost under the Interference of Strong Static Electricity and more Stable.
- Lock Type: Electronic
- Employ International standard 5-Bolt Anti-Theft Lock



Rose Gold



Black



Silver

## Hotel Smart Door Lock

### Model: LD-200

- Material: Stainless Steel with Stylish Ultra-Thin Design
- Color: Rose Gold / Silver / Black
- Technology: Employ Electromagnetic Wave Induction Technology, being more Maneuverable.
- Applicable Card: T5577 Mifare One Em4305 ID Card
- Power Supply: 4 AA Alkaline Batteries
- Static Power Consumption:  $<10 \mu\text{A}$
- Dynamic Power Consumption: About 200mA
- Low Voltage Prompt: 4.8V
- Sensing Distance: 3-5cm
- Applicable Temperature:  $-20\text{--}50^{\circ}\text{C}$
- Relative Humidity: 15-85% (Non-Condensing)
- Anti-Static:  $>15.000\text{V}$
- It Ensures the Information won't be Lost under the Interference of Strong Static Electricity and more Stable.
- Lock Type: Electronic
- Lock Features: Employ International Standard 5-Bolt Anti-Theft Lock

## Hotel Smart Door Lock

Model: LD-212



- Color: Silver
- Technology: Employ Electromagnetic Wave Induction Technology, being more Maneuverable.
- Applicable Card: T5577 Mifare One Em4305 ID Card
- Power Supply: 4 AA Alkaline Batteries
- Static Power Consumption: <math><10 \mu\text{A}</math>
- Dynamic Power Consumption: About 200mA
- Low Voltage Prompt: 4.8V
- Sensing Distance: 3-5cm
- Applicable Temperature:  $-20\text{--}50^{\circ}\text{C}$
- Relative Humidity: 15-85% (Non-Condensing)
- Anti-Static:  $>15.000\text{V}$
- It Ensures the Information won't be Lost under the Interference of Strong Static Electricity and more Stable.
- Lock Type: Electronic
- Lock Features: Employ International Standard 5-Bolt Anti-Theft Lock.



Bronze



Copper



Black



## Hotel Smart Door Lock

Model: LD-115

- Size: 380x190x140mm
- GW: 2Kgs



Hotel Energy Saver



Hotel Card Encoder



# TROULLIDES

Hotel Dustbin

Galilaiou 1 Latsia, 2233 Nisolia

Tel.: 22 488515, 22 483643 Fax: 22 488515

Email: [info@troullides.com.cy](mailto:info@troullides.com.cy), [taster@cytanet.com.cy](mailto:taster@cytanet.com.cy) <http://www.troullides.com.cy>

## Pedal Dustbin Model: H-8018

- Capacity: 3 Litres
- Size:  $\Phi$  169xH:270mm
- #410 Stainless Steel Material / Fire Safe Construction Design
- Plastic Liner for Easy Cleaning / Polished Finish



## Pedal Dustbin Model: H-8019

- Capacity: 5 Litres
- Size:  $\Phi$  205xH:265mm
- #410 Stainless Steel Material / Fire Safe Construction Design
- Plastic Liner for Easy Cleaning / Polished Finish



## Pedal Dustbin Model: H-8020

- Capacity: 12 Litres
- Size:  $\Phi$  252xH:402mm
- #410 Stainless Steel Material / Fire Safe Construction Design
- Plastic Liner for Easy Cleaning / Polished Finish



## Pedal Dustbin Model: WD-ST-5L

- Capacity: 5 Litres
- #410 Stainless Steel Material
- Fire Safe Construction Design
- Plastic Liner for Easy Cleaning
- Color: Silver Matte
- Buffer Closing Device



## Pedal Dustbin Model: WD-ST-7L

- Capacity: 7 Litres
- #410 Stainless Steel Material
- Fire Safe Construction Design
- Plastic Liner for Easy Cleaning
- Color: Silver Matte
- Buffer Closing Device



## Pedal Dustbin Model: WD-ST-8L

- Capacity: 8 Litres
- #410 Stainless Steel Material
- Fire Safe Construction Design
- Plastic Liner for Easy Cleaning
- Color: Silver Matte
- Buffer Closing Device



## Pedal Dustbin Model: WD-ST-10L

- Capacity: 10 Litres
- #410 Stainless Steel Material
- Fire Safe Construction Design
- Plastic Liner for Easy Cleaning
- Color: Silver Matte
- Buffer Closing Device



## Pedal Dustbin Model: WD-ST-12L

- Capacity: 12 Litres
- #410 Stainless Steel Material
- Fire Safe Construction Design
- Plastic Liner for Easy Cleaning
- Color: Silver Matte
- Buffer Closing Device



## Oval Waste Bin Model: OB-02

- Capacity: 10 Litres
- Siz : L:25.5xW:19.5xH:27cm
- Double Layer Waste Bi
- Outer: Wrapped with PU Leather (Different colors and styles for leather are available).
- Inner: Iron Painte
- With Chrome To



## Round Waste Bin Model: RB-01

- Capacity: 10 Litres
- Siz : 225xH:270mm
- Double Layer Waste Bi
- Outer: Wrapped with PU Leather (Different colors and styles for leather are available).
- Inner: Iron Painte
- With Chrome To



### Stainless Steel Ring

Thicker, smooth and nice, firmly wrapped in the garbage bag.

### Iron Material Inner Layer Bin

Use iron material, high quality and durable, not easy to deform.



### PU Cover Design

Use PU material, full of texture.

### Rubber Bottom Ring

Prevent sliding sideways, not easy to wear the bottom surface.



## TWO KINDS OF SHAPE

Round shape and oval shape



## Pedal Dustbin Model: WD-A1-5L

- Capacity: 5 Litres
- #410 Stainless Steel Material
- Fire Safe Construction Design
- Plastic Liner for Easy Cleaning
- Color: Silver Matte
- Buffer Closing Device



## Pedal Dustbin Model: WD-A1-7L

- Capacity: 7 Litres
- #410 Stainless Steel Material
- Fire Safe Construction Design
- Plastic Liner for Easy Cleaning
- Color: Silver Matte
- Buffer Closing Device



## Pedal Dustbin Model: WD-A1-9L

- Capacity: 9 Litres
- #410 Stainless Steel Material
- Fire Safe Construction Design
- Plastic Liner for Easy Cleaning
- Color: Silver Matte
- Buffer Closing Device



## Pedal Dustbin Model: WD-A1-12L

- Capacity: 12 Litres
- #410 Stainless Steel Material
- Fire Safe Construction Design
- Plastic Liner for Easy Cleaning
- Color: Silver Matte
- Buffer Closing Device



## Dustbin Model: WD-R1-5L

- Capacity: 5 Litres
- Size: 225x225x292mm
- #410 Stainless Steel Material
- Fire Safe Construction Design
- Plastic Liner for Easy Cleaning
- Color: Silver Matte



## Dustbin Model: WD-R1-7L

- Capacity: 7 Litres
- Size: 225x225x334mm
- #410 Stainless Steel Material
- Fire Safe Construction Design
- Plastic Liner for Easy Cleaning
- Color: Silver Matte



## Dustbin Model: WD-R1-9L

- Capacity: 9 Litres
- Size: 250x250x340mm
- #410 Stainless Steel Material
- Fire Safe Construction Design
- Plastic Liner for Easy Cleaning
- Color: Silver Matte



## Dustbin Model: WD-R1-12L

- Capacity: 12 Litres
- Size: 250x250x385mm
- #410 Stainless Steel Material
- Fire Safe Construction Design
- Plastic Liner for Easy Cleaning
- Color: Silver Matte





# TROULLIDES

## Hotel Electric Kettle Tray Set

Galilaiou 1 Latsia, 2233 Nisolia

Tel.: 22 488515, 22 483643 Fax: 22 488515

Email: [info@troullides.com.cy](mailto:info@troullides.com.cy), [taster@cytanet.com.cy](mailto:taster@cytanet.com.cy) <http://www.troullides.com.cy>



Kettle

- Capacity: 0.8Ltr
- Power Supply: 220-240V 50/60Hz 1000-1200W
- #304 Stainless Steel + Branded Controller
- Automatic Shut-Off
- Color: Matt Finish

Tray

- Three in one tray
- Size: 36.3x24x3.3cm
- Material: ABS
- Color: Black





Model: I-H1202



Size: 36.3x24x3.3cm  
Material: ABS



Model: F-H1202



Size: 36.5x34x3.8cm  
Material: Melamine

Kettle

- Capacity: 1.2Ltr
- Power Supply: 220-240V 50/60Hz 1350-1600W
- #304 Stainless Steel + Branded Controller
- Automatic Shut-Off
- Color: Matt Finish

Tray

- Color: Black





**Model: I-H1268**



Tray

- Size: 36.3x24x3.3cm
- Material: ABS
- Color: Black



**Model: M-H1268**



Tray Drawer Type

- Three in One Tray
- Size: 26.7x19x8cm
- Material: ABS
- Color: Black

Kettle

- Capacity: 0.8Ltr
- Power Supply: 220-240V 50/60Hz 1000-1200W
- Double Body Design
- #304 Stainless Steel + Branded Controller
- Matt Finish
- Automatic Shut-Off



Spout  
Anti-Cutting

Mat  
surface-fingerprint  
proof





Model: I-H1208



Size: 36.3x24x3.3cm



Model: G-H1208



Size: 44.3x22.7x3.6cm



Kettle

- Capacity: 0.8Ltr
  - Power Supply: 220-240V 50/60Hz 800-1000W
  - #304 Stainless Steel + Branded Controller
  - Automatic Shut-Off
  - Color: Matt Finish
- Tray
- Three in One Tray
  - Material: ABS
  - Color: Black

**HEALTHY**

Food-Grade  
#304 Stainless  
Steel+Food  
Grade Plastic





Model: G-H1208  
Gun



Size: 44.3x22.7x3.6cm



Model: I-H1208  
Gun



Size: 36.3x24x3.3cm

Kettle

- Capacity: 0.8Ltr
- Power Supply: 220-240V 50/60Hz 800-1000W
- #304 Stainless Steel + Branded Controller
- Automatic Shut-Off
- Color: Gun

Tray

- Three in One Tray
- Material: ABS
- Color: Black



**STAINLESS STEEL**  
Stainless steel cover  
More safety for health

**STYLISH DURABLE  
304 STAINLESS STEEL  
BODY**

Not easy to rust for  
long-term use



**LIGHT  
INDICATOR**



Model: I-H1261



Size: 36.3x24x3.3cm



Model: G-H1261



Size: 44.3x22.7x3.6cm

Kettle

- Capacity: 0.6Ltr
- Power Supply: 220-240V 50/60Hz 1000-1200W
- #304 Stainless Steel + Branded Controller
- Automatic Shut-Off
- Color: Matt Finish

Tray

- Three in One Tray
- Material: ABS
- Color: Black





## Model: H-H1202

### Kettle

- Capacity: 1.2Ltr
- Power Supply: 220-240V 50/60Hz 1000-1200W
- #304 Stainless Steel+Branded Controller
- Automatic Shut-Off
- Color: Matt Finish

### Tea Box

- Size: 18.5x13.7x11cm
- Material: Melamine
- Color: Black

### Service Tray

- Size: 42.9x18.3x2.9cm
- Material: Melamine
- Color: Black

### Main Tray

- Size: 46.2x36.9x6.2cm
- Material: Melamine
- Color: Black



## Model: H-H2002

### Kettle

- Capacity: 1.2Ltr
- Power Supply: 220-240V 50/60Hz 1000-1200W
- #304 Stainless Steel+Branded Controller
- Automatic Shut-Off
- Color: Matt Finish

### Tea Box

- Size: 18.5x13.7x11cm
- Material: Melamine
- Color: Black

### Service Tray

- Size: 42.9x18.3x2.9cm
- Material: Melamine
- Color: Black

### Main Tray

- Size: 46.2x36.9x6.2cm
- Material: Melamine
- Color: Black





Kettle

- Capacity: 1.0Ltr
- Power Supply: 220-240V 50/60Hz 1000-1200W
- #304 Stainless Steel + Branded Controller
- With Water Gauge Indicator
- Automatic Shut-Off
- Color: Matt Finish

Tray

- Three in One Tray
- Size: 36.3x24x3.3cm
- Material: ABS
- Color: Black



**STRUCTURE DIAGRAM**





## Model: C-H2002 Black

### Kettle

- Capacity: 1.2Ltr
- Power Supply: 220-240V 50/60Hz 1350-1600W
- Double Body Designed: Build in #304 Stainless Steel + Food Grade PP Shell Housing
- Branded Controller
- Automatic Shut-Off
- Color: Black

### Tea Box

- Size: 15.5x11.5x5cm
- Material: Melamine
- Color: Black

### Service Tray

- Size: 33.5x13.2x1.1cm
- Material: Melamine
- Color: Black

### Main Tray

- Size: 38.5x32.5x2.25cm
- Material: Melamine
- Color: Black

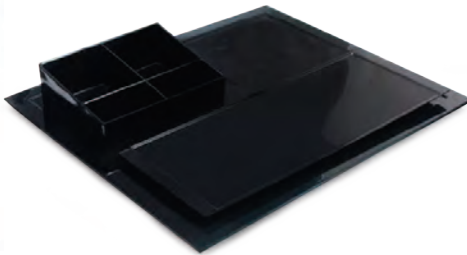

## Model: A-H1202

### Kettle

- Capacity: 1.2Ltr
- Power Supply: 220-240V 50/60Hz 1350-1600W
- #304 Stainless Steel Inside + Local Controller
- Type: Stainless Steel
- Automatic Shut-Off
- Color: Matt Finish

### Tea Box

- Size: 13x10x4cm
- Material: Melamine
- Color: Black

### Service Tray

- Size: 34.5x13.8x2cm
- Material: Melamine
- Color: Black

### Main Tray

- Size: 34.5x31.5x2.2cm
- Material: Melamine
- Color: Black





## Model: G-H1206

### Ivory

#### Kettle

- Capacity: 1.2Ltr
- Power Supply: 220-240V 50/60Hz 1000-1200W
- Double Body Designed: Build in #304 Stainless Steel + Food Grade PP Shell Housing
- Branded Controller
- Automatic Shut-Off
- Color: Ivory

#### Tray

- Three in One Tray
- Size: 44.3x22.7x3.6cm
- Material: ABS
- Color: Ivory

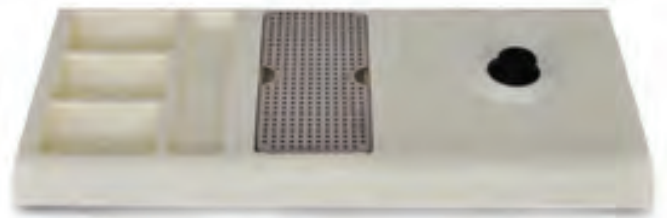

## Model: G-H1206

### Black

#### Kettle

- Capacity: 1.2Ltr
- Power Supply: 220-240V 50/60Hz 1000-1200W
- Double Body Designed: Build in #304 Stainless Steel + Food Grade PP Shell Housing
- Branded Controller
- Automatic Shut-Off
- Color: Black

#### Tray

- Three in One Tray
- Size: 44.3x22.7x3.6cm
- Material: ABS
- Color: Black





## Model: G-K81

### Kettle

- Capacity: 0.8Ltr
- Power Supply: 220-240V 50/60Hz 1350-1600W
- #316 Seamless Stainless Steel, Anti-Rust & Anti-Oxidation
- Mat Finishing
- Double Layer, Anti-Scald
- Weldless Inside, Easy for Cleaning
- Branded Controller
- Automatic Shut-Off
- Black or White for Option



### Tray

- Size: 44.3x22.7x3.6cm
- Material: ABS • Color: Black



K81 BLACK



K81 WHITE



## Model: G-K85

### Kettle

- Capacity: 0.8Ltr
- Power Supply: 220-240V 50/60Hz 1350-1600W
- #316 Seamless Stainless Steel, Anti-Rust & Anti-Oxidation
- Mat Finishing
- Double Layer, Anti-Scald
- Weldless Inside, Easy for Cleaning
- Branded Controller
- Automatic Shut-Off
- Silver or Gold for Option



### Tray

- Size: 44.3x22.7x3.6cm
- Material: ABS • Color: Black



K85 SILVER



K85 GOLD



**Model: B-H1266**  
**Black**



Tea Box

- Size: 15.5x11.5x5cm
- Material: Melamine
- Color: Black

Service Tray

- Size: 33.5x13.2x1.1cm
- Material: Melamine
- Color: Black

Main Tray

- Size: 38.5x32.5x2.25cm
- Material: Melamine
- Color: Black



**Model: G-H1266**  
**Black**



Tray

- Size: 44.3x22.7x3.6cm
- Material: ABS
- Color: Black



Kettle

- Capacity: 1.2Ltr
- Power Supply: 220-240V 50/60Hz 1500-1800W
- Double Body Designed: Build In #304 Stainless Steel + Food Grade PP Shell Housing
- Branded Controller
- Automatic Shut-Off
- Color: Black





**Model: K-H1263**



Tray

- Size: 40.5x26.8x3.8cm
- Material: ABS
- Color: Black



**Model: I-H1263**



Tray

- Three in One Tray
- Size: 36.3x24x3.3cm
- Material: ABS
- Color: Black



Kettle

- Capacity: 0.6Ltr
- Power Supply: 220-240V 50/60HZ 1000-1200W
- #304 Stainless Steel + Branded Controller
- With Water Gauge Indicator
- Automatic Shut-Off
- Color: Matt Finish





## Model: M-H1263

### Kettle

- Capacity: 0.6Ltr
- Power Supply: 220-240V 50/60Hz 1000-1200W
- #304 Stainless Steel + Branded Controller
- With Water Gauge Indicator
- Matt Finish
- Automatic Shut-Off



### **HEALTHY**

Food-Grade #304 Stainless Steel + Food Grade Plastic



## Model: M-H1208

### Kettle

- Capacity: 0.8Ltr
- Power Supply: 220-240V 50/60Hz 800-1000W
- #304 Stainless Steel + Branded Controller
- Color: Matt Finish
- Automatic Shut-Off



**STYLISH DURABLE**  
**304 STAINLESS STEEL BODY**  
 Anti-Rust / Anti-Oxidation

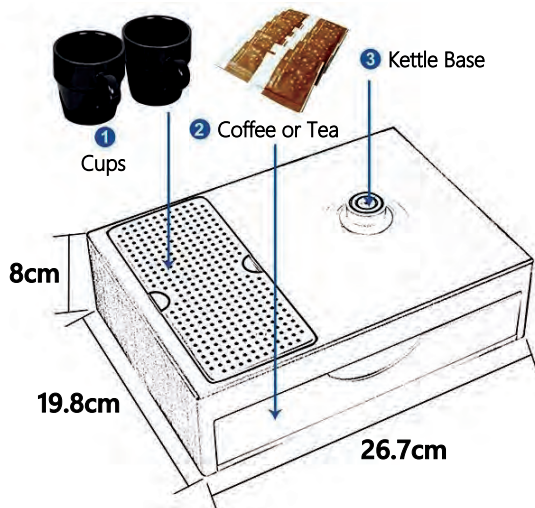

### Tray

- Drawer Type Three in One Tray
- Size: 26.7x19.8cm
- Material: ABS
- Color: Black



Kettle

- Capacity: 0.8Ltr
- Power Supply: 220-240V  
50/60Hz 800-1000W
- #304 Stainless Steel +  
Branded Controller
- Color: Matt Finish
- Automatic Shut-Off

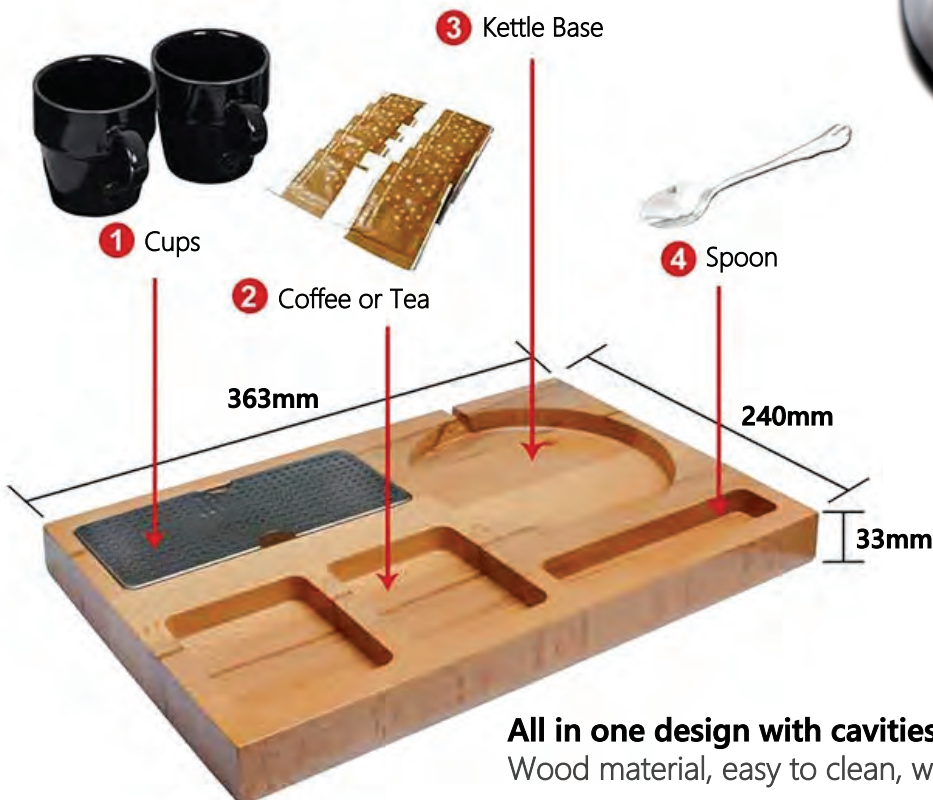

Tray

- Three in One Tray
- Size: 36.3x24x3.3cm
- Material: Wooden  
(Beach Wood)

**All in one design with cavities for sachets, spoon & cups**  
Wood material, easy to clean, waterproof



**Model: J-H1206  
Golden**

Kettle

- Capacity: 1.2Ltr
- Power Supply: 220-240V 50/60HZ 1000-1200W
- Double Body Designed: Build in #304 Stainless Steel + Food Grade PP Shell Housing
- Branded Controller
- Automatic Shut-Off
- Color: Golden

Tray

- Three in One Tray
- Size: 42x30x3cm
- Material: Melamine
- Color: Black



Ergonomic Handle



Switch



Outlet



Filter



**Model: J-H1206  
Black**

Kettle

- Capacity: 1.2Ltr
- Power Supply: 220-240V 50/60HZ 1000-1200W
- Double Body Designed: Build in #304 Stainless Steel + Food Grade PP Shell Housing
- Branded Controller
- Automatic Shut-Off
- Color: Black

Tray

- Three in One Tray
- Size: 42x30x3cm
- Material: Melamine
- Color: Black





## Model: G-H1205

### Matt

#### Kettle

- Capacity: 1.2Ltr
- Power Supply: 220-240V 50/60HZ 1000-1200W
- #304 Stainless Steel + Branded Controller
- Automatic Shut-Off
- Color: Matt Finish



**HEALTHY**  
Food-Grade #304 Stainless Steel + Food Grade Plastic



#### Tray

- Three in One Tray
- Size: 44.3x22.7x3.6cm
- Material: ABS • Color: Black



## Model: B-H1206-1

#### Kettle

- Capacity: 1.0Ltr
- Power Supply: 220-240V 50/60Hz 1000-1200W
- #304 Stainless Steel
- Branded Controller
- Automatic Shut-Off
- Color: Black



#### Tea Box

- Size: 15.5x11.5x5cm
- Material: Melamine
- Color: Black

#### Service Tray

- Size: 33.5x13.2x1.1cm
- Material: Melamine
- Color: Black



#### Main Tray

- Size: 38.5x32.5x2.25cm
- Material: Melamine
- Color: Black



Kettle

- Capacity: 0.8Ltr
- Power Supply: 220-240V 50/60Hz 1000-1200W
- #304 Stainless Steel
- Branded Controller
- Automatic Shut-Off
- Color: Matt Finish

Tray

- Size: 40.5x26.8x3.8cm
- Material: ABS
- Color: Black



**HEALTHY**

Food-Grade #304 Stainless Steel + Food Grade Plastic

**STYLISH DURABLE #304 STAINLESS STEEL BODY**

Anti-rust / Anti-oxidation



**All in one design with cavities for sachets, spoon & cups**

ABS material, high temperature resistant, easy to clean, waterproof



## Model: G-H0881S

### Kettle

- Capacity: 0.8Ltr
- Power Supply: 220-240V 50/60Hz 1000-1200W
- #304 Stainless Steel + Branded Controller
- Type: Stainless Steel
- Automatic Shut-Off
- Color: Matt Finish

### Tray

- Size: 44.3x22.7x3.6cm
- Material: ABS
- Color: Black



## Model: I-H0880S

### Kettle

- Capacity: 0.8Ltr
- Power Supply: 220-240V 50/60Hz 1000-1200W
- Double Body Design: Build In #304 Stainless Steel + Food Grade PP Shell Housing
- Branded Controller
- Automatic Shut-Off
- Color: Black



### Tray

- Three in One Tray
- Size: 36.3x24x3.3cm
- Material: ABS • Color: Black





Kettle

- Capacity: 0.6Ltr
- Power Supply: 220-240V 50/60Hz 1000W
- Build In #304 Stainless Steel + Food Grade PP Shell Housing
- With Water Gauge Indicator
- Automatic Shut-Off

Tray

- Three in One Tray
- Size: 36.3x24x3.3cm
- Material: ABS
- Color: White

- Double Layer Body with Anti-Scald Design
- Inner Part: Food Grade #304 Stainless Steel
- Outer Shell: Anti-Scald PP Plastic Shell



Inner Part  
Food Grade #304  
Stainless Steel

Outer Shell  
Anti-Scald  
PP Plastic  
Shell

**Water Level Gauge Window**

- Silicon Surface for Water Window
- Water Inlet for Water Window
- Stainless Steel Sealed Interior for Preventing Boiling the Silicon and keeping fresh taste



• Color: Black

- Food Grade #304 Stainless Steel Inner Body Design
- More Durable and Safe for Using
- Stainless Steel Spout
- Stainless Steel Lid



Spout

Food Grade Stainless Steel Interior

Thermal-Protective PP Plastic Outer Shell

Water Window

Light Indicator

Hinged Trigger Locking Lid

On/Off Button

Easy-Grip Handle

360 Degree Rotational Base



**Model: J**  
Melamine Tray  
Base Size: 400x270x38mm  
Color: Black



**Model: K**  
ABS Tray  
Base Size: 400x270x38mm  
Color: Black



**Model: W**  
Light Wooden Tray  
Base Size: 363x240x33mm  
Color: Beach Wood



**Model: G**  
ABS Tray  
Base Size: 443x227x36mm  
Color: Black or White

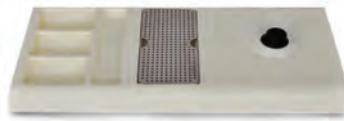

**Model: I**  
ABS Tray  
Base Size: 363x240x33mm  
Color: Black or White



**Model: A**  
Melamine Tray  
Base Size: 345x315x22.5mm  
Color: Black or White

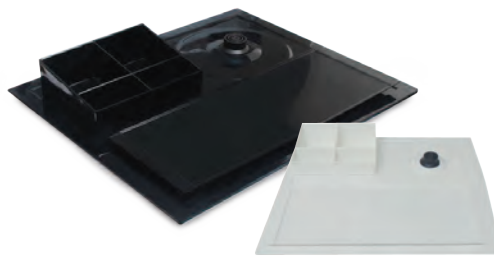

**Model: B**  
Melamine Tray  
Base Size: 385x308x22.5mm  
Color: Black or White

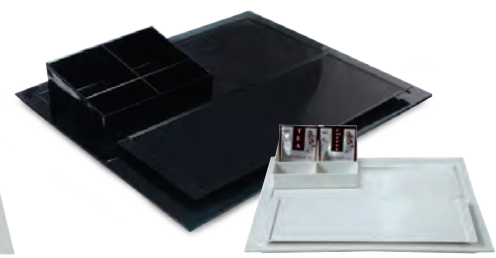

**Model: C**  
Melamine Tray  
Base Size: 385x308x22.5mm  
Color: Black or White



**Model: F**  
Melamine Tray  
Base Size: 365x340x38mm  
Color: Black



**Model: H**  
Melamine Tray  
Base Size: 453x356x22.5mm  
Color: Black



**Model: M**  
Drawer Type Tray  
Base Size: 26.7x19.8x8cm  
Color: Black

## Electric Kettle



**Model H1261**

Capacity: 0.6Ltr  
Power: 1000-1200W  
Color: Matt Finish



**Model: H0881S**

Capacity: 0.8Ltr  
Power: 1000-1200W  
Color: Matt Finish



**Model: H0880S**

Capacity: 0.8Ltr  
Power: 1000-1200W  
Color: Black or Ivory



**Model: H1202**

Capacity: 1.2Ltr  
Power: 1350-1600W  
Color: Matt Finish



**Model: H2002**

Capacity: 1.2Ltr  
Power: 1350-1600W  
Color: Black or Ivory



**Model: H1266**

Capacity: 1.2Ltr  
Power: 1500-1800W  
Color: Black or White



**Model: H1268**

Capacity: 0.8Ltr  
Power: 1000-1200W  
Color: Black Matt Finish or White Matt Finish



**Model:K85**  
Capacity:0.8Ltr  
Power: 1350-1600W  
Color:Gold, Silver



**Model:K81**  
Capacity:0.8Ltr  
Power: 1350-1600W  
Color:White or Black



**Model: H1206**  
Capacity: 1.2Ltr  
Power: 1000-1200W  
Color:Ivory, Black, Golden, Matt Finish



**Model:H1208**  
Capacity:0.8Ltr  
Power: 800-1000W  
Color:Gun or Matt Finish



**Model: H1263**  
Capacity: 0.6Ltr  
Power: 1000-1200W  
Color: Matt Finish

**Model:H1206-1**  
Capacity: 1.0Ltr  
Power: 1000-1200W  
Color:Matt Finish



**Model:H1262**  
Capacity: 0.6Ltr  
Power: 850W  
Color: Black or White



# TROULLIDES

Hotel Hangers  
Clothesline - Shoehorn

Galilaiou 1 Latsia, 2233 Nisolia

Tel.: 22 488515, 22 483643 Fax: 22 488515

Email: [info@troullides.com.cy](mailto:info@troullides.com.cy), [taster@cytanet.com.cy](mailto:taster@cytanet.com.cy) <http://www.troullides.com.cy>

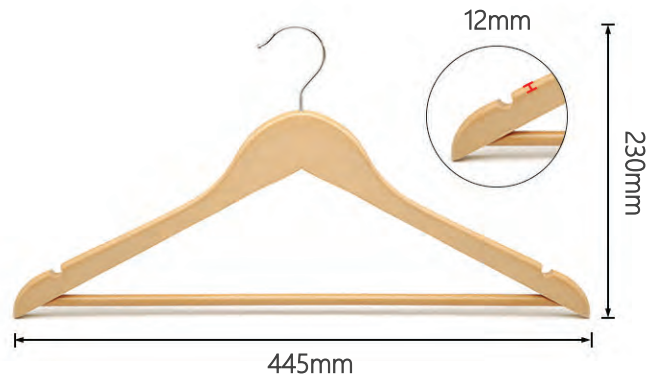

## Wooden Clothes Hanger

Model: 6125N

- Size: 44.5x1.2cm
- Color: Natural
- Style: Straight Thicken
- Packing: 130pcs / ctn



## Wooden Clothes Hanger

Model: R019NR

- Size: 44.5x2.5x4.5cm
- Color: Natural
- Style: Straight Thicken
- Packing: 45pcs / ctn



Shirt

Blouse

Pants

Men's Suit

# Wooden Clothes Hanger with Clips

Model: 6125NS

- Size: 44.5x1.2cm
- Color: Natural
- Style: Straight Thicken with Clips
- Packing: 120pcs / ctn

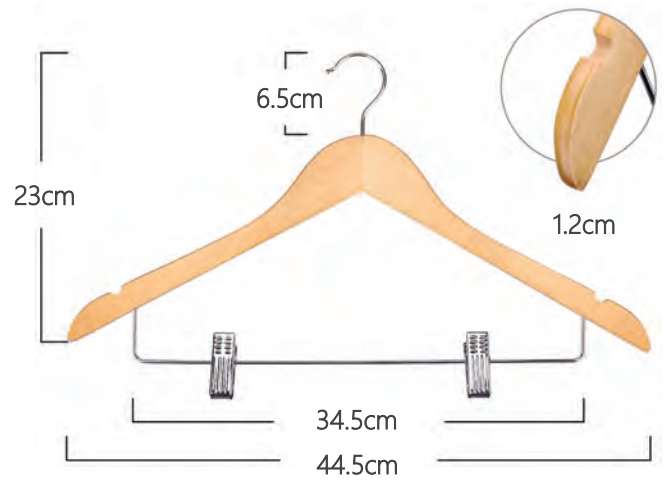

### 360° Swivel Hook

Free adjustment to fit different hanging space.

**Adjustable Metal Clips**  
With non-slip rubber inside to prevent clothes scratch.



**Notched Design**  
Considerate notched design for camisole and slip dress.



**Stainless Steel Material**  
Anti-rust steel with smooth edges, more durable.

**Premium Wood**  
Smooth edge and round corner, prevents scratch to clothes.



## VERSATILE USE



Shirts



Pants



Slip Dress





**Black Satin Padded  
Sweater Hanger  
Model: SB1**

- Black Satin with Chrome Holder
- Size: 38cm
- 200pcs / ctn
- Non-Slip Rubber Covered Hook
- Strong & Durable



The size is suitable for different clothes

Strong plastic tube coated hook.



Thickness: 3.5cm

Length: 38cm



High quality solid wood, high density sponge and thick satin. Smooth and soft finish protect your clothes from abrasing.

Dedicate and elegant bow.



No more hanger marks on the shoulders.





**Retractable Clothesline  
Stainless Steel 3.8m  
Model: F-12**

- Shape: Round
- Material: Retractable Stainless Steel
- Line Length: 3.8m
- Steel Wire Rope
- Product Size: 90x90x55mm
- Packing Box Size: 9.6x9.6x6cm

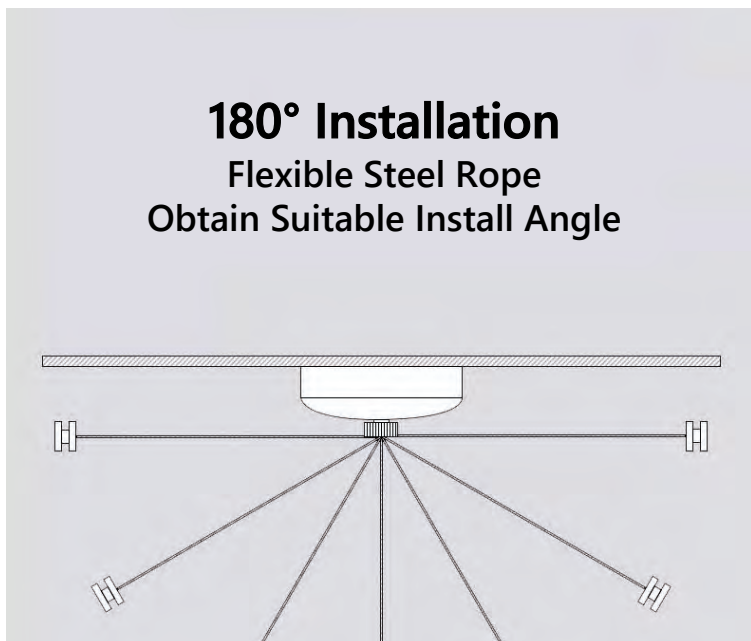



## Hotel Round Wood Clothes Brush 38cm Model: #38

- Size: 38cm (len) x 6cm (wid) x 3.5cm (thi.)
- Color: Mahogany
- Accessories: 2cm Black Bristles
- Wood Material
- Round Head
- With Hanging Strap
- 38cm Long
- Packing: 144pcs per carton



## Hotel Wood Shoe Horn 38cm Model: SHOEHORN

- Size Length: 38cm
- Color: Mahogany
- Material: Wood
- Square Head
- With Hanging Strap





# TROULLIDES

Hotel Leather Products

Galilaiou 1 Latsia, 2233 Nisolia

Tel.: 22 488515, 22 483643 Fax: 22 488515

Email: [info@troullides.com.cy](mailto:info@troullides.com.cy), [taster@cytanet.com.cy](mailto:taster@cytanet.com.cy) <http://www.troullides.com.cy>



### Hotel Table Clock with Light

- Size: 130x60x153mm



### Hotel Remote Control Holder Double

- Size: L:360xW:100xH:240mm



### Hotel Rectangle Tissue Box

- Size: 240x125x65mm
- Leather Color can be Option



### Hotel Tissue Box Brown

- Size: 14x14x15cm
- Leather Color can be Option



### Hotel Small Leather Note Pad

- Size: 190x130mm
- Leather Color can be Option



# TROULLIDES

Hotel Room Luggage Rack

Galilaiou 1 Latsia, 2233 Nisolia

Tel.: 22 488515, 22 483643 Fax: 22 488515

Email: [info@troullides.com.cy](mailto:info@troullides.com.cy), [taster@cytanet.com.cy](mailto:taster@cytanet.com.cy) <http://www.troullides.com.cy>

## Stainless Steel Luggage Rack Model: HM7215D

- Strong metal frame with silver chrome
- 4 Black durable straps
- Easy fold up
- Size: L:550xW:500xH:700mm



Has bumper to protect walls and keep luggage on the rack



Folding storage, easy to store



Comes with 4 heavy duty black woven straps

Extended rear legs for increased stability

Available in black powder coated



**Perfect Foldable Rack**  
For storing luggage, travel cases and more



Skid-Resistant Footpads



Robust Metal Hinge



Heavy Duty Strap



# TROULLIDES

Hotel Soap Dispenser

Galilaiou 1 Latsia, 2233 Nisosia

Tel.: 22 488515, 22 483643 Fax: 22 488515

Email: [info@troullides.com.cy](mailto:info@troullides.com.cy), [taster@cytanet.com.cy](mailto:taster@cytanet.com.cy) <http://www.troullides.com.cy>



## Single Soap Dispenser Stainless Steel Pull Type - Wall Mounted

Model: HS-7118H

- Single Shower Soap
- 304 Stainless Steel
- Size: L:122xW:100xH:241mm
- Capacity: 350ml
- Transparent PC
- Metal T-Bar



## Double Soap Dispenser Stainless Steel Pull Type - Wall Mounted

Model: HS-7118H-2

- Double Shower Soap
- #304 Stainless Steel
- Size: L:216xW:100xH:241mm
- Capacity: 2x350ml
- Transparent PC
- Metal T-Bar





## Automatic Soap Dispenser Touchless Model: HS-1806

- Material: ABS Plastic
- Capacity: 1000ml
- Battery Version: 4pcs Type C Batteries (not included)
- External Electric Version: 100-240V Electric Adapter (additional)
- Pump Type: Gel (Liquid) or Spray or Foam
- Output: 1.0ml
- Color: White
- Dispenser Size: L:140xW:100xH:268mm



THE WAY TO OPEN



Liquid / Gel



Spray



## Automatic Soap Dispenser Touchless Model: HS-1808

- Material: ABS Plastic
- Capacity: 1000ml
- Battery Version: 4pcs Type C Batteries (not included)
- External Electric Version: 100-240V Electric Adapter (additional)
- Pump Type: Gel (Liquid) or Spray or Foam
- Output: 1.0ml
- Unit Product Weight: 0.9Kg
- Color: White
- Dimensions: L:123xW:114xH:261.5mm



Spray



Liquid / Gel



Foam

**High Sensitivity Sensor**



## Automatic Table Top Soap Dispenser Touchless Model: HS-1808

- Material: ABS Plastic Waterproof Material
- Capacity: 350ml
- Sensor Response Speed is 0.25 Seconds
- Sensing Distance: <5cm
- Input: DC-5V / 1A
- Rated Power: 1.5W
- Pump Type: Foam / Spray / Gel
- Output: 0.7ml
- Unit Product Weight: 0.26Kg
- Color: White
- Dimensions: L:72xW:89xH:188mm



## Manual Liquid Soap Dispenser Wall Mounted Model: CD-1008A

- Material: PC and ABS Plastic
- Capacity: 300ml
- Type: Manual
- Pump Type: Liquid Soap / Shampoo and Liquid Cream
- Color: Transparent and White
- Dimensions: L:65xW:82xH:160mm



# Wet Wipes Dispenser Wall Mounted Silicone Nozzle

Model: WD-01

- Material: Plastic
- Suitable Wet Wipes Diameter: 22cm
- Silicone Nozzle
- Color: Black
- Product Size: H:32.4xL:26.6xW:23.7cm



Silicone

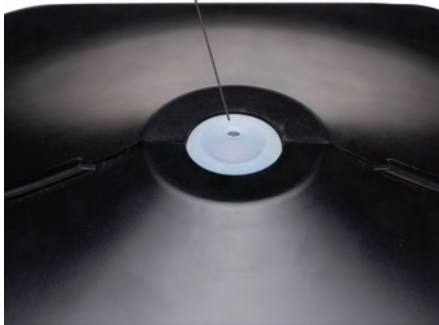

Wall Mounted





# TROULLIDES

## Hotel Coffee Machine

Galilaiou 1 Latsia, 2233 Nisosia

Tel.: 22 488515, 22 483643 Fax: 22 488515

Email: [info@troullides.com.cy](mailto:info@troullides.com.cy), [taster@cytanet.com.cy](mailto:taster@cytanet.com.cy) <http://www.troullides.com.cy>

# Coffee Machine

## Model: EM-201

- 220V-240V~50Hz 1400W
- 19 Bar Pump Powerful Pressure for Rich Taste
- 800ml Detachable Transparent Water Tank
- Adjustable Cup Support & Drip Tray
- Compatible with Nespresso Capsule
- Auto Power Off in 5 Minute in Energy Saving Mode
- With Overheating and Overpressure Protected Device, Safe and Reliable.
- Product Size: 300x120x230mm
- White Box Size: 340x170x270mm



Compatible with nespresso capsule



19 Bar high pressure extraction



Automatic power-off in 30 minutes



Easy operation



800ml water tank



Food grade material



espresso

cappuccino

latte



mocha

caramel macchiato

iced mocha





# TROULLIDES

Hotel Safety Hair Dryer

Galilaiou 1 Latsia, 2233 Nisosia

Tel.: 22 488515, 22 483643 Fax: 22 488515

Email: [info@troullides.com.cy](mailto:info@troullides.com.cy), [taster@cytanet.com.cy](mailto:taster@cytanet.com.cy) <http://www.troullides.com.cy>



## Hotel Wall Mounted Hair Dryer Holder with Shaver Socket 1200W Model: D01A

- Power Supply: 220-240V 50-60Hz 1200W
- Wall Mounted Hair Dryer which will be easy for Management
- Imported Motor, Stable Quality and Lower Noise
- Low Repair Rate
- High-Low Two Speed for Option
- With Shaver Socket 110 & 220V
- Automatically Off if Over-Heat



Air Outlet



Switch



Back



Cooling Port



## Hotel Wall Mounted Hair Dryer Holder 1200W Model: D01B

- Power Supply: 220-240V 50-60Hz 1200W
- Wall Mounted Hair Dryer which will be easy for Management
- Imported Motor, Stable Quality and Lower Noise
- Low Repair Rate
- High-Low Two Speed for Option
- Automatically Off if Over-Heat



Overheating Protection



Stylish and Easy to Manage



Retractable Spiral Cord



Safety Switch, Press to Work



CE Approved



Hot Wind Two Speed



## Hotel Silent Wall Mounted Hair Dryer With Holder Stand 1200W Model: D02B

- Power Supply: 220-240V 50-60Hz 1200W
- Wall Mounted Hair Dryer which will be easy for Management
- Imported Motor, Stable Quality and Lower Noise
- Low Repair Rate
- High-Low Two Speed for Option
- Automatically Off if Over-Heat



## Hotel Wall Mounted Hair Dryer With Stand 1200W Model: D03

- Power Supply: 220-240V 50-60Hz 1200W
- Wall Mounted Hair Dryer which will be easy for Management
- Imported Motor, Stable Quality and Lower Noise
- Low Repair Rate
- High-Low Two Speed for Option
- Automatically Off if Over-Heat





## Hotel Wall Mounted Hair Dryer 1200W With Shaver Socket Model: D07 Black / D07 White

- Power Supply: 220-240V 50-60Hz 1200W with 220V Shaver Socket
- Wall Mounted Hair Dryer which will be Easy for Management
- Imported Motor, Stable Quality and Lower Noise
- Low Repair Rate
- Two Speed Hot Wind + Cool Wind for Option
- Automatically Off if Over-Heat
- With Base
- Color: Black or White



## Hotel Wall Mounted Hair Dryer 1600W Model: D07-2B / D07-2W

- Power Supply: 220-240V 50-60Hz 1600W
- Wall Mounted Hair Dryer which will be Easy for Management
- Imported Motor, Stable Quality and Lower Noise
- Low Repair Rate
- Two Speed Hot Wind + Cool Wind for Option
- Automatically Off if Over-Heat
- With Base
- Color: Black or White



Coil made of Special Material  
To Ensure Bounce Back & Return  
to Shape and Length



Safety On/Off  
Press Switch

Wall Holder  
Featurew Anti-Theft  
Cable Tracks



Converts to Wall  
Mounted with  
Holder Option

2 Speed Hot Wind  
+ Cool Wind  
Settings



Air Outlet



Cooling Port



Concentrator



Switch



- Power Supply: 220-240V 50-60Hz 1800-2100W
- Full Function Hair Dryer for High and Hotel
- Imported Motor, Stable Quality and Lower Noise
- Low Repair Rate
- Safety Switch
- Three Speed Hot Wind
- Foldable Handle
- With Hang-Up Loop
- Two Cold Wind Switch
- Ionic Function makes the Hair more Soft

**SAFETY THERMOSTAT  
OVER HEATING  
Circuit Protection**



**REMOVABLE  
Concentrator**

+

**FOLDABLE  
Handle**

—



Removable Net  
Easy for Cleaning



Coil made of  
Special Material  
Retractable Spiral Cord



Hanging Loop  
Convenient to Storage



Safety On/Off  
Press Switch



Ionic Function



Three Heating Settings  
Two Speeds Control

**Folding Hair Dryer 1800-2100W  
Model: F2B**

- Power Supply: 220-240V 50-60Hz 1800-2100W
- Full Function Hair Dryer for High and Hotel
- Imported Motor, Stable Quality and Lower Noise
- Low Repair Rate
- Safety Switch
- Three Speed Hot Wind
- Foldable Handle
- With Hang-Up Loop
- Two Cold Wind Switch
- Ionic Function makes the Hair more Soft
- With Base





## Folding Hair Dryer 1800-2100W Model: F13 Matte

- Power Supply: 220-240V 50-60Hz 1800-2100W
- Full Function Hair Dryer for High-End Hotel
- Imported Motor, Stable Quality and Lower Noise
- Low Repair Rate
- Safety Switch
- Two Speed Hot Wind + Cold Wind
- Foldable Handle
- With Hang-Up Loop
- Mat Black



Matte design, sophisticated Anti-fouling and anti-fingerprint

20mm concentrate blow hole higher blowing power quick styling and quick drying



Filter back lid design prevent hair suck in

Foldable

### EHD, Even Heat Distribution Tecnology

Smooth air flow, extended range, quick drying Using all new waved heating wire design, enable rapid, balance and stable heating. Material can endure high temperature, longer service life.



SAFETY

Three adjustments hot and cold air, damage free on hair



Safe switch release hand and cut off power



Outlet

Filter

Safety On/Off Press Switch

Two Cold Wind Switch



## Folding Hair Dryer 1600W Model: F7W

- Power Supply: 220-240V 50-60Hz 1600W
- Safety Switch
- Three Speed Temperature
- Two Speed Wind
- Foldable Handle
- With Hang-Up Loop

SAFETY THERMOSTAT OVER HEATING  
Circuit Protection

REMOVABLE  
Concentrator  
+



FOLDABLE  
Handle  
-

Coil made of special material  
Straight power cord  
(Retractable spiral cord for option)



Safety On/Off Press Switch



Portable Folding



Two Heating Settings



## Folding Hair Dryer 1200W Model: F12 Black

- Power Supply: 220-240V 50-60Hz 1200W
- Small and Easy for Storage
- Two Speed Hot Wind
- Foldable Handle
- With Hang-Up Loop



Intercept



Switch



Cooling Port



Black Color

## Folding Mini Hair Dryer 1400W Model: F6 Black Model: F6S Golden

- Power Supply: 220-240V 50-60Hz 1400W
- Small and Easy for Storage
- Two Speed Hot Wind
- With Cold Wind Button
- Foldable Handle
- With Hang-Up Loop
- Safety Switch



Black and Golden Color



Cooling Port



Switch



Air Outlet



Foldable Handle



### Product Size





## Folding Hair Dryer 1200W Model: F5 Black

- Power Supply: 220-240V 50-60Hz 1200W
- 1 Cool Wind, 2 Speed Hot Wind
- Over Heating Protection
- Zigzag Heater
- Low Noise
- Black Color

**SAFETY THERMOSTAT OVER HEATING**  
Circuit Protection

**REMOVABLE**  
Concentrator



**FOLDABLE**  
Handle



**Chrome Plated**  
Matching color  
concentrator



**Safety On/Off**  
Press Switch



**Coil Made of**  
Special Material  
Retractable spiral  
cord for option



**Hanging Loop**  
Convenient to  
storage



**Foldable Handle**



**Two Heating**  
Settings



## Hair Dryer 1200W Model: D07-3 Black

- Power Supply: 220-240V 50-60Hz 1200W
- Stable Quality and Lower Noise
- Low Repair Rate
- Two Speed Hot Wind + Cool Wind for Option
- Automatically Off if Over-Heat



**LOWER NOISE**  
Imported Motor,  
Stable Quality



Air Outlet



Cooling Port



Concentrator



Switch



Air Collecting  
Port

Outlet

Cooling Port

Safety On/Off  
Press Switch

2 Speed  
Hot Wind +  
Cool Wind  
Settings



- Voltage: 220-240V, 50-60Hz
- Rated Power: 1800W
- Air Flow: 54Km/h
- Weight: 2.2Kgs
- Cbm/Ctn: 58x56x54cm
- White / Silver / Golden Color for Options



Install Drawing

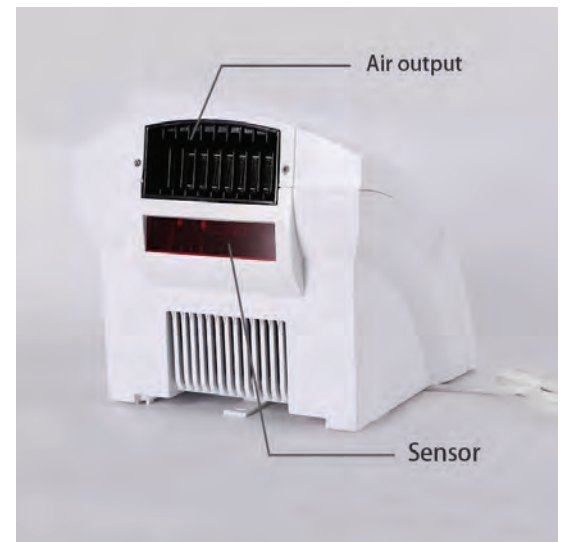
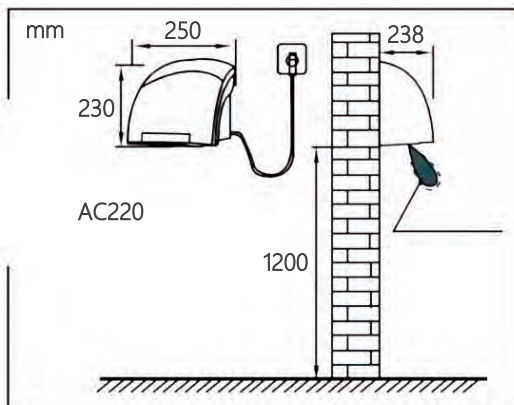



# TROULLIDES

Hotel Ironing Station

Galilaiou 1 Latsia, 2233 Nisolia

Tel.: 22 488515, 22 483643 Fax: 22 488515

Email: [info@troullides.com.cy](mailto:info@troullides.com.cy), [taster@cytanet.com.cy](mailto:taster@cytanet.com.cy) <http://www.troullides.com.cy>



## Hotel Steam Iron 1800W Adjustable Temperature for Different Fabrics Dry/Spray/Steam Model: HS-05

- Power Supply: 220-240V 50-60Hz 1800W
- Adjustable Temperature for Different Fabrics Dry/Spray/Steam/Burst Steam/Self-Cleaning/Anti-Calc/Anti-Drip/Auto Shut-Off
- Water Tank Capacity: 320ml
- Dial Thermostat Control
- Temperature Pilot Light
- Soft Handle
- Soleplate: Ceramic
- Unit Size: L:292xW:121xH:145mm
- Soleplate Size: L:219xW:121mm



## Hotel Portable Dry Iron 1000W Model: HS-08

- Power Supply: 220-240V 50-60Hz 1000W
- Function: Dry / Adjustable Temperature Settings for Different Fabrics / Over Heat Safety Protection / Temperature Pilot Light
- Non-Stick Soleplate
- Auto-Shut Off
- Power Cord: 1.8m
- Unit Dimension: 265x103x132mm
- Giftbox Dimension: 270x110x136mm

- Power Supply: 220-240V 50-60Hz 1800W
- Adjustable Temperature for Different Fabrics  
Dry/Spray/Steam/Burst Steam/Self-Cleaning/  
Anti-Calc/Anti-Drip/Auto Shut-Off
- Water Tank Capacity: 320ml
- Dial Thermostat Control
- Temperature Pilot Light
- Soft Handle
- Soleplate: Ceramic
- Unit Size: L:292xW:121xH:145mm
- Soleplate Size: L:219xW:121mm

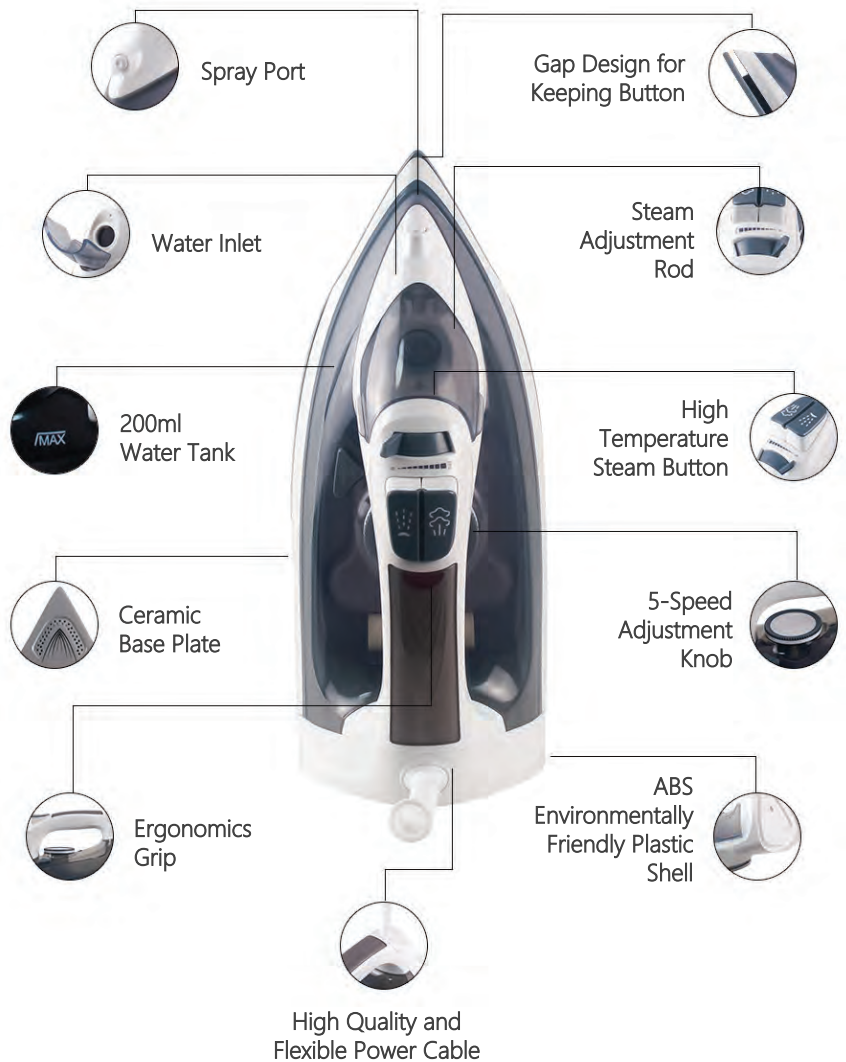



## Hotel Wardrobe Ironing Holder Anti-Theft

Model: IB03-3 & 5 Silver

- Ironing Holder with Anti-Theft Spare Parts
- Apply to Hang Ironing Board into Hotel Wardrobe
- Color: Silver
- Size: L:40xW:12.8xH:12cm



Rotable Iron Holder



Stores Neatly on Rail



Anti-Theft Cable Lock



## Hotel Wardrobe Ironing Holder Anti-Theft

Model: IB05-3 & 5 Black

- Ironing Holder with Anti-Theft Spare Parts
- Apply to Hang Ironing Board into Hotel Wardrobe
- Color: Black
- Size: H:29.5xW:13.5cm



Hotel Guestroom Ironing Centre  
Anti-Theft Design Fixed Metal Iron Rest



## Hotel Wardrobe Ironing Holder

Model: IB04-4 Black

- Ironing Holder Hanging to Wardrobe
- Color: Black
- Size: L:43.5xW:13xH:16cm

Stores Neatly on Rail



Ant-Drip Cable Lock



## Hotel Wardrobe Ironing Holder

Model: IB04-5 Black

- Ironing Holder Hanging to Wardrobe
- Color: Black
- Size: L:13xW:14xH:42cm

Rotable Iron Holster





## Wall Mounted Iron Hook Model: IB09

- Material: Metal
- Apply to Hand Ironing Board
- Color: Black



## Wall Mounted Ironing Holder Model: IB02-5 White

- Wall Mounted Type Ironing Holder
- Apply to Hand Ironing Board
- Color: White
- Size: H:35xW:13.5cm



## Wall Mounted Ironing Holder Model: IB02-5 Black

- Wall Mounted Type Ironing Holder
- Apply to Hand Ironing Board
- Color: Black
- Size: H:35xW:13.5cm





## Ironing Board with Iron Rest Model: IB01 Silver

- Color: Silver
- Full Size (With Iron Rest) 112x30cm
- Board Size: 92x30cm
- Maximum Height: 78cm
- Height Adjustment: 7 Levels
- Thickening Foam + Felt: 10mm
- Thickness of the Surface: 0.8mm
- Rugged Tube Frame Legs:  $\Phi 22/\Phi 28/\Phi 32\text{mm}$



Extra Thick Build-In Support Rods



Anti-Fire Fabric



## Metal Mesh Top Ironing Board with Iron Rest Anti-Fire Fabric Model: IB01 (NEW) Silver

- Board Size: 91x30cm
- Material: Steel
- Surface Treatment: Powder Coating
- Cover: Anti-Fire Fabric
- Thickness of Felt: 10mm
- Diameter of Round Leg:  $\Phi 22/\Phi 28/\Phi 32\text{mm}$
- Total Height: 79cm, Adjustment Height
- Packing: Each pc Shink Wrapped, 4pcs/ctn
- Legs:  $\Phi 22/\Phi 28/\Phi 32\text{mm}$



Feed Tubes Fixed Hook



Safety Crimping Design



Regulating Handle



Flexible Legs Cover

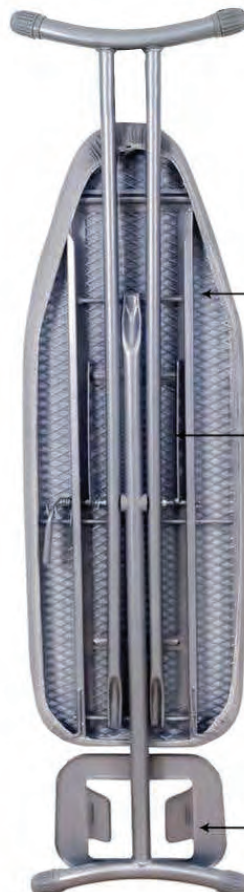
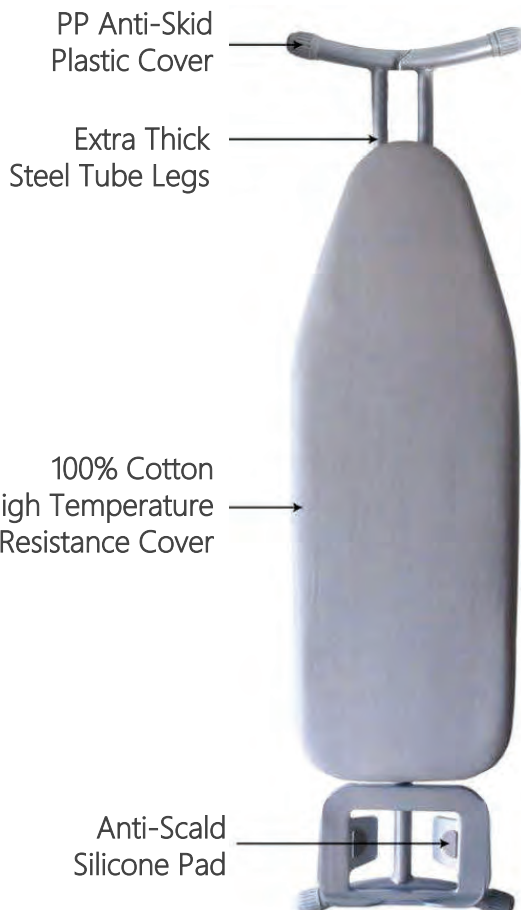



## Ironing Board Model: IB03 Silver

- Steam Flow Metal Mesh
- Thickening Foam + Felt: 10mm
- Rugged Tube Frame Legs:  $\Phi 22/\Phi 28/\Phi 32$ mm
- Smooth Binding Edges to with Stand Fraying
- Cover Material: Cotton with Felt Underlay
- Frame Color: Silver Gray
- Board Color: Silver Gray
- Board Size: 110x33cm
- Maximum Height: 85cm
- Height Adjustment: 7 Levels



## Ironing Board Cover

- Color: Silver
- Apply for IB03 Ironing Board



## Ironing Board Model: IB05 Black

- Steam Flow Metal Mesh
- Thickening Foam + Felt: 10mm
- Rugged Tube Frame Legs:  $\Phi 28/\Phi 28/\Phi 32$ mm
- Smooth Binding Edges to with Stand Fraying
- Cover Material: Cotton with Felt Underlay
- Frame Color: Black
- Board Color: Black
- Board Size: 110x33cm
- Maximum Height: 85cm
- Height Adjustment: 7 Levels

## Ironing Board Model: IB06 Black

- Steam Flow Metal Mesh
- Thickening Foam + Felt: 10mm
- Rugged Tube Frame Legs:  $\Phi 28/\Phi 28/\Phi 32$ mm
- Smooth Binding Edges to with Stand Fraying
- Cover Material: Cotton with Felt Underlay
- Frame Color: Black
- Board Color: Black
- Board Size: 97x33cm
- Maximum Height: 76cm
- Height Adjustment: 7 Levels





### Ironing Board with Hanging Hook Model: IB07 Silver

- Color: Silver
- Full Size (With Iron Rest): 110x30cm
- Board Size: 90x30cm
- Maximum Height: 76cm
- Height Adjustment: 7 Levels
- Thickening Foam + Felt: 10mm
- Thickness of the Surface: 0.8mm
- Rugged Tube Frame Legs:  $\Phi 22/\Phi 28/\Phi 32\text{mm}$

### Ironing Board with Hanging Hook Model: IB08 Silver

- Steam Flow Metal Mesh
- Thickening Foam + Felt: 10mm
- Rugged Tube Frame Legs:  $\Phi 28/\Phi 28/\Phi 32\text{mm}$
- Smooth Binding Edges to with Stand Fraying
- Cover Material: Cotton with Felt Underlay
- Frame Color: Black
- Board Color: Black
- Full Size (with Iron Rest): 140x34cm
- Board Size: 110x34cm
- Maximum Height: 85cm
- Height Adjustment: 7 Levels

## Ironing Board NEW HANG-IN WARDROPE STYLE

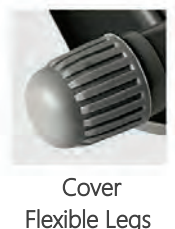
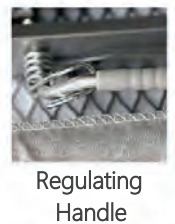
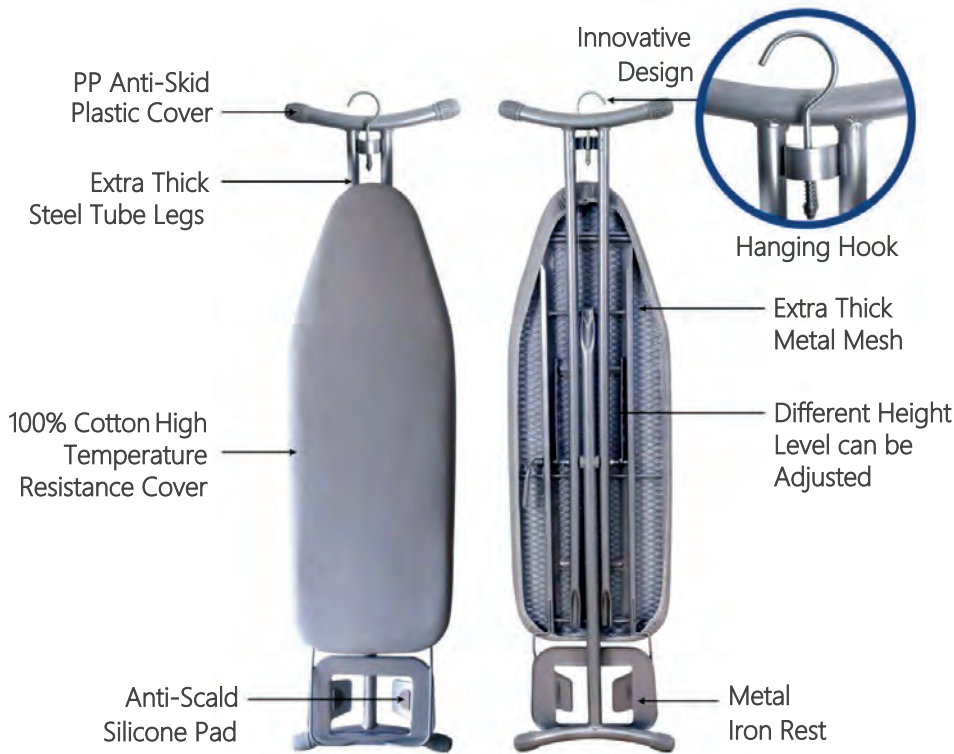

### Ironing Board with Iron Rest Model: IB08-1 Black

- Steam Flow Metal Mesh
- Thickening Foam + Felt: 10mm
- Rugged Tube Frame Legs:  $\Phi 28/\Phi 28/\Phi 32\text{mm}$
- Smooth Binding Edges to with Stand Fraying
- Cover Material: Cotton with Felt Underlay
- Frame Color: Black
- Board Color: Black
- Board Size: 110x33cm
- Maximum Height: 85cm
- Height Adjustment: 7 Levels

### Ironing Board with Hanging Hook Model: IB08 Black

- Steam Flow Metal Mesh
- Thickening Foam + Felt: 10mm
- Rugged Tube Frame Legs:  $\Phi 28/\Phi 28/\Phi 32\text{mm}$
- Smooth Binding Edges to with Stand Fraying
- Cover Material: Cotton with Felt Underlay
- Frame Color: Black
- Board Color: Black
- Full Size (with Iron Rest): 140x34cm
- Board Size: 110x34cm
- Maximum Height: 85cm
- Height Adjustment: 7 Levels



# TROULLIDES

## Hotel Magnifying Mirror

Galilaiou 1 Latsia, 2233 Nisolia

Tel.: 22 488515, 22 483643 Fax: 22 488515

Email: [info@troullides.com.cy](mailto:info@troullides.com.cy), [taster@cytanet.com.cy](mailto:taster@cytanet.com.cy) <http://www.troullides.com.cy>



### Desktop Magnifying Mirror 6"

Model: HS-726A

- $\Phi$  6 Inches
- Mirror Finish, Double Side - One Side is 3X Magnifying
- Desktop Vanity Mirror

### Desktop Magnifying Mirror 8"

Model: HS-726B

- $\Phi$  8 Inches



### Desktop Magnifying Mirror 8" With LED Light Model: HS-826

- Diameter: 8"
- Desktop Mirror with LED Light
- 3X Magnification, Single Side
- Material: Copper
- Voltage: 110V/220V
- LED Life Span: 60000 Hours



**Desktop Magnifying Mirror 8"  
With LED Light  
Model: HS-5218**

- Diameter: 8"
- Desktop Mirror with LED Light
- 3X Magnification, Single Side
- Material: Copper
- Voltage: 110V/220V
- LED Life Span: 60000 Hours



**Desktop Magnifying Mirror 6"  
With Adjustable Height  
Model: HS-806A**

- $\Phi$  6 Inches
- Height can be Adjustable, the Height from 36cm - 43cm
- Mirror Finish, Double Side - One Side is 3X Magnifying
- Desktop Vanity Mirror

**Desktop Magnifying Mirror 8"  
With Adjustable Height  
Model: HS-806B**

- $\Phi$  8 Inches

**Desktop Magnifying Mirror 8"  
Model: QL-928**

- Diameter: 8 Inches
- Material: Stainless Steel + Copper
- Double Side Mirror - One Side is 10X Magnifying





**Wall Mounted Magnifying Mirror 6"**  
**Model: HT-67A Silver**

- $\Phi$  6 Inches
- Color: Silver
- Mirror Finish, Double Side - One Side is 3X Magnifying
- Wall Mounted Vanity Mirror

**Wall Mounted Magnifying Mirror 8"**  
**Model: HT-67 Silver**

- $\Phi$  8 Inches
- Color: Silver



**Wall Mounted Magnifying Mirror 6"**  
**Model: HT-67A Gold**

- $\Phi$  6 Inches
- Color: Gold
- Mirror Finish, Double Side - One Side is 3X Magnifying
- Wall Mounted Vanity Mirror

**Wall Mounted Magnifying Mirror 8"**  
**Model: HT-67B Gold**

- $\Phi$  8 Inches
- Color: Gold





**Wall Mounted Magnifying Mirror 6"**  
**Model: HT-66A**

- $\Phi$  6 Inches
- Mirror Finish, Double Side - One Side is 3X Magnifying
- Wall Mounted Vanity Mirror
- Base: 4.8x22.6cm (1.9"x9.0")

**Wall Mounted Magnifying Mirror 8"**  
**Model: HT-66**

- $\Phi$  8 Inches



**Wall Mounted Magnifying Mirror 8"**  
**With LED Light**  
**Model: HS-519**

- Diameter: 8 Inches
- Thickness: 2.0cm
- 3X Magnification, Double Side
- Voltage: 110V/220V
- Material: Copper
- LED Life Span: 60000 Hours

**Wall Mounted Magnifying Mirror 8.5"**  
**With LED Light**  
**Model: HS-529**

- Diameter: 8.5 Inches
- Thickness: 5.5cm





## Wall Mounted Magnifying Mirror 8.5" With LED Light

Model: HS-509

- Diameter: 8.5 Inches
- 3X Magnification, Double Side
- Voltage: 110V/220V
- Material: Copper
- LED Life Span: 60000 Hours

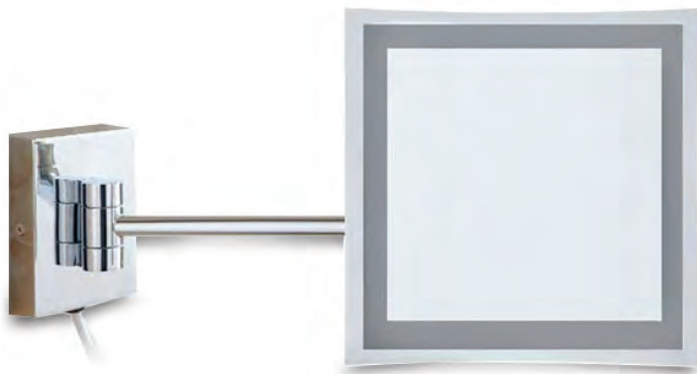

## Wall Mounted Magnifying Mirror L:21.2xW:21.2cm - With LED Light Model: HS-539

- L:21.2xW:21.2cm
- 3X Magnification, Single Side
- Voltage: 110V/220V
- Material: Copper
- LED Life Span: 60000 Hours

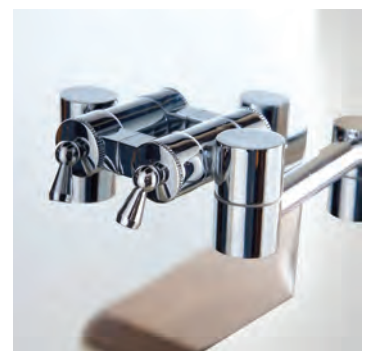



## Wall Mounted Magnifying Mirror L:22xW:16cm - With LED Light Model: HS-559

- L:22xW:16cm
- 3X Magnification, Single Side
- Voltage: 110V/220V
- Material: Copper
- LED Life Span: 60000 Hours



---

## Wall Mounted Magnifying Mirror Square

Model: QL-3238

- Square Mirror
- Mirror Finish, Single Side in 3X Magnifying
- Wall Mounted Vanity Mirror in Square Shape
- Without LED Light





# TROULLIDES

Hotel Mini Bar Refrigerator

Galilaiou 1 Latsia, 2233 Nisolia

Tel.: 22 488515, 22 483643 Fax: 22 488515

Email: [info@troullides.com.cy](mailto:info@troullides.com.cy), [taster@cytanet.com.cy](mailto:taster@cytanet.com.cy) <http://www.troullides.com.cy>



## Semiconductor Mini Bar 30Ltr

Model: HS-30A

- Capacity: 30Ltr
- ECO Temp: 6-12°C
- Automatically Evaporating Drain Water
- Margic Shelf Design, Convenient for Storing Different Size of Drinks
- Internal LED Light
- Insulation: Cyclopentane
- Heater Power: 10W
- Optionals Color: Black, White
- Size: W:420xD:400xH:485mm
- Power Supply: 220-240V 50/60Hz 48W



**Low Noise 30dB**  
No Compressor, No Vibration

**FAST COOLING**  
**ENERGY SAVING**

Environmental Protection ECO-Friendly



Inside View



## Semiconductor Mini Bar 42Ltr

Model: HS-42A

- Capacity: 42Ltr
- ECO Temp: 5-12°C
- Automatically Evaporating Drain Water
- Margic Shelf Design, Convenient for Storing Different Sizes of Drinks
- Internal LED Light
- Insulation: Cyclopentane
- Heater Power: 10W
- 220-240V 50/60Hz 48W
- Size: 420x420x515mm
- Optionals Color: Black, White

Color: Black



Solid Door



Three-Dimensional Heat Dissipation Hole



Temperature Adjustment Knob



New Semiconductor Devices



Inside View



Color: White

## Semiconductor Mini Bar Clear Glass Door 30Ltr Model: HS-30G

- Capacity: 30Ltr
- Type: Glass Door
- ECO Temp: 10-15°C
- Automatically Evaporating Drain Water
- Margic Shelf Design, Convenient for Storing Different Size of Drinks
- Internal LED Light
- Insulation: Cyclopentane
- Heater Power: 10W
- Optionals Color: Black, White
- Size: W:420xD:400xH:485mm
- Power Supply: 220-240V 50/60Hz 48W



**No compressor,  
No vibration,  
Low noise 30db**  
No mechanical movement,  
Long endurance



Temperature  
Adjustment  
Knob



New Semiconductor  
Devices, Strong  
Refrigeration



Three-Dimensional  
Heat Dissipation Hole,  
Rapid Heat Dissipation



## Semiconductor Mini Bar Clear Glass Door 42Ltr Model: HS-42G

- Capacity: 42Ltr
- Type: Glass Door
- ECO Temp: 10-15°C
- Automatically Evaporating Drain Water
- Margic Shelf Design, Convenient for Storing Different Size of Drinks
- Internal LED Light
- Insulation: Cyclopentane
- Heater Power: 10W
- 220-240V 50/60Hz 48W
- Size: 420x420x515mm
- Optionals Color: Black, White



Air-Tight Seal



Adjustable Feet



Soft LED Light



Temperature Control

Reversible Door

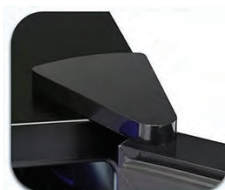

You can open the door from  
the right or open the  
door from the left



## Semiconductor Mini Bar 17Ltr

Model: BC-17B

- Capacity: 17Ltr
- ECO Temp 5-10°C
- Automatically Evaporating Drain Water
- Margic Shelf Design, Convenient for Storing Different Sizes of Drinks
- Internal LED Light
- Insulation: Cyclopentane
- Heater Power: 10W
- 220-240V 50/60Hz 48W
- Size: 385x341x415mm
- Optionals Color: Black, White



## Semiconductor Mini Bar 46Ltr

Model: HS-46C

- Capacity: 46Ltr
- ECO Temp 8-18°C
- Automatically Evaporating Drain Water
- Margic Shelf Design, Convenient for Storing Different Sizes of Drinks
- Internal LED Light
- Insulation: Cyclopentane
- Heater Power: 10W
- 220-240V 50/60Hz 48W
- Size: 435x480x510mm
- Optionals Color: Black, White

## Semiconductor Mini Bar 50Ltr

Model: BC-50B1

- Capacity: 50Ltr
- ECO Temp 5-15°C
- Automatically Evaporating Drain Water
- Margic Shelf Design, Convenient for Storing Different Sizes of Drinks
- Internal LED Light
- Insulation: Cyclopentane
- Heater Power: 10W
- 220-240V 50/60Hz 48W
- Size: L:500xD:420xH:518mm
- Optionals Color: Black, White



Color: Black



Color: White



Color: White



Color: Black

## Semiconductor Mini Bar 65Ltr

Model: BC-65A

- Capacity: 65Ltr
- Type: Solid Door
- ECO Temp 5-15°C
- Automatically Evaporating Drain Water
- Margic Shelf Design, Convenient for Storing Different Sizes of Drinks
- Internal LED Light
- Insulation: Cyclopentane
- Heater Power: 10W
- 220-240V 50/60Hz 48W
- Size: 460x738x540mm
- Optionals Color: Black, White



## Heat Absorption Mini Bar 20Ltr Model: CB-20SA

- Capacity: 20Ltr
- ECO Temp: 8°C
- Dimensions: W:360xD:390xH:440mm
- 220-240V 50/60Hz 63W
- Automatically Evaporating Drain Water
- Margic Shelf Design, Convenient for Storing Different Size of Drinks
- Reversible Door Design
- Internal LED Light
- Refrigeration: R600a
- Insulation: Cyclopentane
- Heater Power: 10W
- No Compressor, No Vibration, No CFC, No Noise
- Color: Black, White

## Heat Absorption Mini Bar 20Ltr Model: SC-20SA

- Capacity: 20Ltr
- ECO Temp: 12°C (25C Ambient Temperature)
- Dimensions: W:360xD:390xH:440mm
- 220-240V 50/60Hz 63W
- Automatically Evaporating Drain Water
- Margic Shelf Design, Convenient for Storing Different Size of Drinks
- Reversible Door Design
- Internal LED Light
- Refrigeration: R600a
- Insulation: Cyclopentane
- Heater Power: 10W
- No Compressor, No Vibration, No CFC, No Noise
- Color: Black, White



## Heat Absorption Mini Bar 21Ltr Model: CB-21SA

- Capacity: 21Ltr
- ECO Temp: 8°C
- Dimensions: W:385xD:455xH:375mm
- 220-240V 50/60Hz 63W
- Automatically Evaporating Drain Water
- Drawer Type
- A and B Handle
- Internal LED Light
- Refrigeration: R600a
- Insulation: Cyclopentane
- Heater Power: 10W
- No Compressor, No Vibration, No CFC, No Noise, 0dB
- Color: Black, White



## Heat Absorption Mini Bar 28Ltr Model: CB-28SA

- Capacity: 28Ltr
- ECO Temp: 8°C
- Dimensions: W:385xD:385xH:485mm
- 220-240V 50/60Hz 63W
- Automatically Evaporating Drain Water
- Margic Shelf Design, Convenient for Storing Different Size of Drinks
- Reversible Door Design
- Internal LED Light
- Refrigeration: R600a
- Insulation: Cyclopentane
- Heater Power: 10W
- Aluminium Inner
- No Compressor, No Vibration, No CFC, No Noise
- Color: Black, White

## Heat Absorption Mini Bar 28Ltr Model: SC-28SA

- Capacity: 28Ltr
- ECO Temp: 12°C
- Dimensions: W:385xD:385xH:485mm
- 220-240V 50/60Hz 63W
- Automatically Evaporating Drain Water
- Margic Shelf Design, Convenient for Storing Different Size of Drinks
- Reversible Door Design
- Internal LED Light
- Refrigeration: R600a
- Insulation: Cyclopentane
- Heater Power: 10W
- Aluminium Inner
- No Compressor, No Vibration, No CFC, No Noise
- Color: Black, White



Color: White



Color: Black



## Heat Absorption Mini Bar 35Ltr Model: CB-35SA

- Capacity: 35Ltr
- Dimensions: W:383xD:455xH:485mm
- ECO Temp: 8°C
- 220-240V 50/60Hz 63W
- Automatically Evaporating Drain Water
- Margic Shelf Design, Convenient for Storing Different Size of Drinks
- Reversible Door Design
- Internal LED Light
- Refrigeration: R600a
- Insulation: Cyclopentane
- Heater Power: 10W
- Aluminium Inner
- No Compressor, No Vibration, No CFC, No Noise
- Color: Black, White

## Heat Absorption Mini Bar 35Ltr

### Model: CB-35SA

- Capacity: 35Ltr
- Dimensions: W:383xD:455xH:485mm
- ECO Temp: 8°C
- 220-240V 50/60Hz 63W
- Automatically Evaporating Drain Water
- Margic Shelf Design, Convenient for Storing Different Size of Drinks
- Reversible Door Design
- Internal LED Light
- Refrigeration: R600a
- Insulation: Cyclopentane
- Heater Power: 10W
- Aluminium Inner
- No Compressor, No Vibration, No CFC, No Noise
- Color: Black, White



## Heat Absorption

### Mini Bar 40Ltr

#### Model: CB-40SA

- Capacity: 40Ltr
- Dimensions: W:400xD:420xH:570mm
- ECO Temp: 5-12°C
- 220-240V 50/60Hz 63W
- Automatically Evaporating Drain Water
- Margic Shelf Design, Convenient for Storing Different Size of Drinks
- Reversible Door Design
- Internal LED Light
- Refrigeration: R600a
- Insulation: Cyclopentane
- Heater Power: 10W
- No Compressor, No Vibration, No CFC, No Noise
- Color: Black, White

## Heat Absorption

### Mini Bar 40Ltr

#### Model: MBCB-40SA

- Capacity: 40Ltr
- Dimensions: W:400xD:420xH:570mm
- ECO Temp: 5-12°C
- 220-240V 50/60Hz 63W
- Automatically Evaporating Drain Water
- Margic Shelf Design, Convenient for Storing Different Size of Drinks
- Reversible Door Design
- Internal LED Light
- Refrigeration: R600a
- Insulation: Cyclopentane
- Heater Power: 10W
- No Compressor, No Vibration, No CFC, No Noise
- Color: Black, White

## Heat Absorption Mini Bar 40Ltr

### Model: SC-40SA

- Capacity: 40Ltr
- Dimensions: W:400xD:420xH:570mm
- ECO Temp: 12°C
- 220-240V 50/60Hz 63W
- NW/GW: 13.6Kg / 14.9Kg
- Automatically Evaporating Drain Water
- Margic Shelf Design, Convenient for Storing Different Size of Drinks
- Reversible Door Design
- Internal LED Light
- Refrigeration: R600a
- Insulation: Cyclopentane
- Heater Power: 10W
- No Compressor, No Vibration, No CFC, No Noise





## Heat Absorption Mini Bar 30Ltr

### Model: BC-30C

- Capacity: 30Ltr
- Type: Solid Door
- ECO Temp: 0-10°C
- 220-240V 50/60Hz 60W
- Size: W:420xD:395xH:495mm
- Cooling System: Peltier and Heat-Pipe Type
- Noise Level: No Noise, 0dB
- Environmental: No CFC, No Ammonium Hydroxide
- Automatically Evaporating Drain Water
- Margic Shelf Design, Convenient for Storing Different Sizes of Drinks
- Internal LED Light
- Refrigeration: R135A
- Insulation: Cyclopentane
- Heater Power: 10W
- Optionals Color: Black, White

## Heat Absorption Mini Bar 30Ltr

### Model: CB-30SA

- Capacity: 30Ltr
- Dimensions: W:385xD:420xH:470mm
- ECO Temp: 8°C
- 220-240V 50/60Hz 63W
- Automatically Evaporating Drain Water
- Margic Shelf Design, Convenient for Storing Different Size of Drinks
- Reversible Door Design
- Internal LED Light
- Refrigeration: R600a
- Insulation: Cyclopentane
- Heater Power: 10W
- Aluminium Inner
- No Compressor, No Vibration, No CFC, No Noise
- Color: Black, White



## Heat Absorption Mini Bar 30Ltr

### Model: CB-30SA

- Capacity: 30Ltr
- Dimensions: W:385xD:420xH:470mm
- ECO Temp: 8°C
- 220-240V 50/60Hz 63W
- Automatically Evaporating Drain Water
- Margic Shelf Design, Convenient for Storing Different Size of Drinks
- Reversible Door Design
- Internal LED Light
- Refrigeration: R600a
- Insulation: Cyclopentane
- Heater Power: 10W
- Aluminium Inner
- No Compressor, No Vibration, No CFC, No Noise
- Color: Black, White

## Heat Absorption Mini Bar 30Ltr

### Model: BC-30C-G

- Capacity: 30Ltr
- Type: Glass Door
- Dimensions: W:420xD:395xH:495mm
- ECO Temp: 5-12°C
- 220-240V 50/60Hz 60W
- Cooling System: Peltier and Heat-Pipe Type
- Noise Level: No Noise, 0dB
- Environmental: No CFC, No Ammonium Hydroxide
- Automatically Evaporating Drain Water
- Margic Shelf Design, Convenient for Storing Different Size of Drinks
- Internal LED Light
- Insulation: Cyclopentane
- Heater Power: 10W
- Color: Black



## Heat Absorption Mini Bar 25Ltr

### Model: BC-25A

- Capacity: 25Ltr
- Type: Solid Door
- Dimensions: W:380xD:370xH:490mm
- ECO Temp: 3-10°C
- 220-240V 50/60Hz
- Cooling System: Peltier and Heat-Pipe Type
- Noise Level: No Noise, 0dB
- Environmental: No CFC, No Ammonium Hydroxide
- Automatically Evaporating Drain Water
- Margic Shelf Design, Convenient for Storing Different Size of Drinks
- Internal LED Light
- Refrigeration: R135A
- Insulation: Cyclopentane
- Optionals Color: Black, White

## Heat Absorption Mini Bar 25Ltr

### Model: BC-25A -G

- Capacity: 25Ltr
- Type: Glass Door
- Size: W:380xD:370xH:490mm
- ECO Temp: 6-15°C
- 220-240V 50/60Hz 48W
- Cooling System: Peltier and Heat-Pipe Type
- Noise Level: No Noise, 0dB
- Environmental: No CFC, No Ammonium Hydroxide
- Automatically Evaporating Drain Water
- Margic Shelf Design, Convenient for Storing Different Sizes of Drinks
- Internal LED Light
- Refrigeration: R135A
- Insulation: Cyclopentane
- Optionals Color: Black, White





# TROULLIDES

## Hotel Mini Wine Cooler

Galilaiou 1 Latsia, 2233 Nisosia

Tel.: 22 488515, 22 483643 Fax: 22 488515

Email: [info@troullides.com.cy](mailto:info@troullides.com.cy), [taster@cytanet.com.cy](mailto:taster@cytanet.com.cy) <http://www.troullides.com.cy>



## Mini Wine Cooler 48Ltr 18 Bottles

Model: JC-48BW

- 18 Bottles
- Capacity: 48L
- Power: 220-240V 70W
- Temperature: 12-18°C
- With Lock
- Product Size: W:335xH:648xD:513mm



## SPECIFICATIONS



**Simple Operation Panel**  
Temperature Control -12°C-18°C



**Safe and Secure**  
Lockable to prevent any unauthorised access



**UV-Resistant Double-Panel**  
Glass Door - Protects your collection from harmful UV Light



**Interior LED Light**  
Equipped with bright white LED light inside to illuminate your wine collection

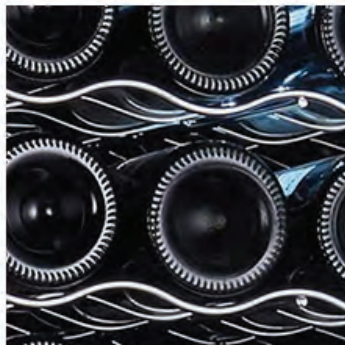

**Flexible Storage**  
The internal storage is customisable with 5 removable chrome wire shelves



**Low Noise - Runs**  
Quietly in the background. Sound Level 30dB



## Mini Wine Cooler 33Ltr, 12 Bottles

Model: JC-33C

- 12 Bottles
- Capacity: 33L
- Voltage: 220-240V 50/60Hz
- Power: 70W
- Cooling Capacity: 12-18°C (Ambient Temperature: 25°C)
- CFC Free, Environmental Friendly
- Sensitive Touch Screen Button for Temperature Control
- Temperature Setting in Centigrade and Fahrenheit
- Tempered Mirror Glass Door
- Soft Interior LED Light
- Product Size: W:25.2xH:61.6xD:51.5cm

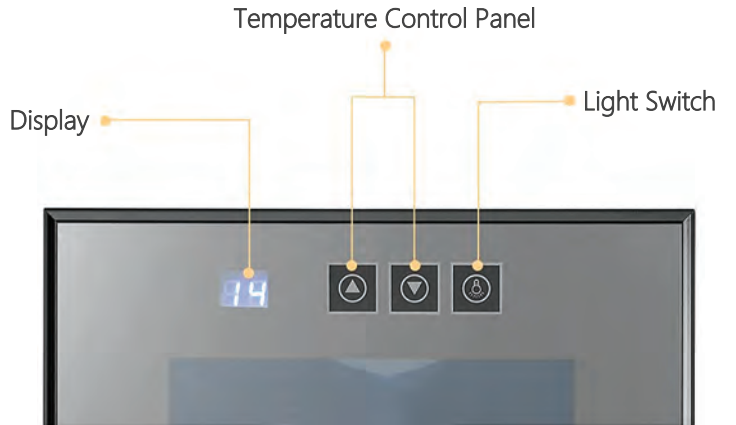

Hidden Hinge



Stainless Steel Shelf

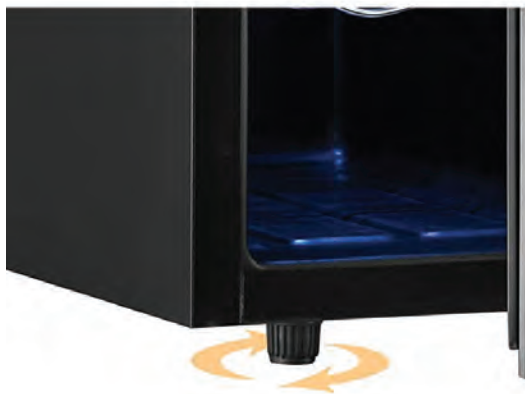

Adjustable Feet



PVC Soft Seal



## Mini Wine Cooler 65Ltr, 28 Bottles Model: JC-65SFV

- 28 Bottles
- Capacity: 65L
- Voltage: 220-240V 50/60Hz
- Power: 75W
- Cooling Capacity: 12-18°C (Ambient Temperature: 25°C)
- CFC Free, Environmental Friendly
- Sensitive Touch Screen Button for Temperature Control
- Temperature Setting in Centigrade and Fahrenheit
- Tempered Mirror Glass Door
- Soft Interior LED Light
- Product Size: W:460xH:735xD:540mm

### Double Toughened Glass

Rugged, resistant to heat, while observing the inside of the wine cabinet

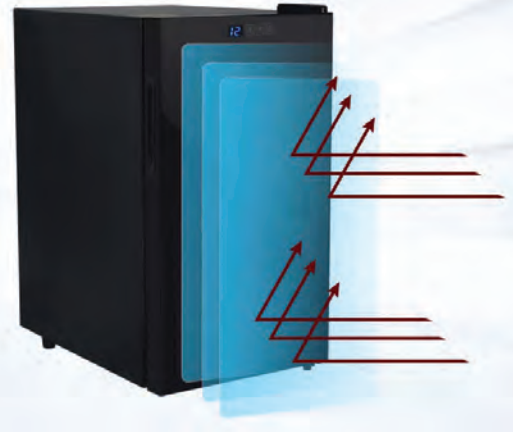

## PRODUCT FEATURES



Semiconductor Refrigeration System



Rapid Cooling



Double-Layered Glass



Shockproof and Silent  
No Noise 0dB



Power: 75W



Smart Lighting



Smart Dual Temperature



Stainless Steel Rack



Stylish Appearance

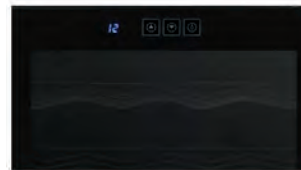

### Temperature Control

Sensitive Touchscreen Control Panel, Fashion Design and Keep the Good Taste

**LED Light**  
Most Comfortable Lighting  
Color Optional  
Longer Service Life



**Fan**  
State of the Art Fan  
Circulated Air Cooling System

**Door**  
Double Tempered Glass  
Frost-Free, No Fog  
Anti-UV Glass  
The Best Sealing





## Mini Wine Cooler 65Ltr, 28 Bottles Model: JC-65SW

- 28 Bottles
- Capacity: 65L
- Voltage: 220-240V 50/60Hz
- Power: 75W
- Cooling Capacity: 12-18°C (Ambient Temperature: 25°C)
- CFC Free, Environmental Friendly
- Sensitive Touch Screen Button for Temperature Control
- Temperature Setting in Centigrade and Fahrenheit
- Tempered Mirror Glass Door
- Soft Interior LED Light
- Product Size: W:460xH:738xD:520mm



## Mini Wine Cooler 78Ltr, 32 Bottles Model: JC-78BFW

- 32 Bottles
- Capacity: 78L
- Voltage: 220-240V 50/60Hz
- Power: 100W
- Cooling Capacity: 12°C-18°C (Ambient Temperature 25°C)
- CFC Free, Environmental Friendly
- Sensitive Touch Screen Button for Temperature Control
- Temperature Setting in Centigrade and Fahrenheit
- Tempered Mirror Glass Door
- Soft Interior LED Light
- Product Size: W:400xH:848xD:512mm

### PRODUCT FEATURES



Semiconductor  
Refrigeration System



Rapid Cooling



Double-Layered Glass



Shockproof and Silent  
No Noise 0dB



Power: 100W



Smart Lighting



Smart Dual  
Temperature



Stainless Steel  
Rack



Stylish  
Appearance

### Double Toughened Glass

Rugged, resistant to heat, while observing the inside of the wine cabinet

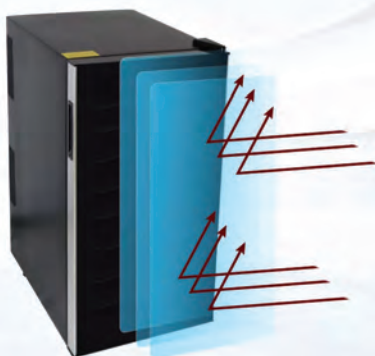



## Mini Wine Cooler 48Ltr, 18 Bottles

Model: JC-48BFW

- 32 Bottles
- Capacity: 78L
- Voltage: 220-240V 50/60Hz
- Power: 70W
- Cooling Capacity: 12°C-18°C
- CFC Free, Environmental Friendly
- Sensitive Touch Screen Button for Temperature Control
- Temperature Setting in Centigrade and Fahrenheit
- Tempered Mirror Glass Door
- Soft Interior LED Light
- Product Size: W:335xH:648xD:511mm



## SPECIFICATIONS



**Smart Touch Digital**  
Thermostat Control the Temperature Easily with the Smart Touch Digital Thermostat.



**UV-Resistant Double-Panel**  
Glass Door - Protects your Collection from Harmful UV Light.



**Interior LED Light**  
Equipped with Bright White LED Light Inside to Illuminate your Wine Collection.



**Flexible Storage**  
The Internal Storage is customisable with 5 Removable Chrome Wire Shelves.



**Low Noise - Runs**  
Quietly in the Background.  
Sound Level 30dB.



# TROULLIDES

Hotel Room Safe Box

Galilaiou 1 Latsia, 2233 Nisolia

Tel.: 22 488515, 22 483643 Fax: 22 488515

Email: [info@troullides.com.cy](mailto:info@troullides.com.cy), [taster@cytanet.com.cy](mailto:taster@cytanet.com.cy) <http://www.troullides.com.cy>



## Hotel Room Safe Box

Model: E2042A

- Product Size: W:420xD:370xH:200mm
- Thickness-Body/Door:  $\Phi$ 1.5/ $\Phi$ 5mm
- Solid, arc-welded heavy-gauge steel construction. Orange peel powder coating finish or sand texture powder coating finish.
- 18mm Solid Steel Bolt for Maximum Security and Durability.
- Pre-Drilled Mounting Holes
- Powered by 4xAA. Automatic Low Battery Level Alert
- LED Display Screen
- User Management: 3-6 Digit Guest Code
- Hotel Management: 6 Digit Override Master Code/Override Mechanical Key
- 5 Minutes Freeze System in Case of Wrong Code for 3 Times

### SOLID STEEL BOLT - DIFFERENT FABRICS

- 18mm solid steel bolt for maximum security and durability.
- Solid, arc-welded heavy-gauge steel construction. Orange peel powder coating finish or sand texture powder coating finish.



## Hotel Room Safe Box

Model: E2042A 15"

- Product Size: W:435xD:370xH:200mm

## Hotel Room Safe Box

Model: E2042A 17"

- Product Size: W:490xD:370xH:200mm

### CIPHER DISK

- LED display screen
- User management: 3-6 digit guest code.
- 5 minutes freeze system in case of wrong code for 3 times.
- Hotel management: 6 digit override master code/override mechanical key.



### LARGE CAPACITY

- Powered by 4 x AA. Automatic low battery level alert.



Jewelry



Important Documents



SLR Camera



Cash



Electronics



## Hotel Room Safe Box

Model: E2042LP

- Product Size: W:420xD:370xH:200mm
- Thickness-Body/Door:  $\Phi$ 1.5/ $\Phi$ 5mm
- Solid, arc-welded heavy-gauge steel construction. Orange peel powder coating finish or sand texture powder coating finish.
- 18mm Solid Steel Bolt for Maximum Security and Durability.
- Pre-Drilled Mounting Holes
- Powered by 4xAA. Automatic Low Battery Level Alert
- LED Display Screen
- User Management: 3-6 Digit Guest Code
- Hotel Management: 6 Digit Override Master Code/Override Mechanical Key
- 5 Minutes Freeze System in Case of Wrong Code for 3 Times



## Hotel Room Safe Box

Model: E2042G - Black

- Product Size: W:420xD:370xH:200mm
- Thickness-Body/Door:  $\Phi$ 1.5/ $\Phi$ 5mm
- Solid, arc-welded heavy-gauge steel construction. Orange peel powder coating finish or sand texture powder coating finish.
- 18mm Solid Steel Bolt for Maximum Security and Durability.
- Pre-Drilled Mounting Holes
- Powered by 4xAA. Automatic Low Battery Level Alert
- LED Display Screen
- User Management: 3-6 Digit Guest Code
- Hotel Management: 6 Digit Override Master Code/Override Mechanical Key
- 5 Minutes Freeze System in Case of Wrong Code for 3 Times
- Color: Black

**ELECTRONIC CODE LOCK  
CONCEALED KEY HOLE DESIGN**  
Easy for hotel management



Digital Password  
Hidden Key Hole



**ELABORATE DESIGN,  
ORIGINALITY CRAFTSMANSHIP**

Freeze system in case of wrong code for 3 times, meanwhile password hiding function for option



LED Display Screen

Electronic Key Panel

Semi-Automatic Electronic Lock

Wall-Mounted Screw Hole

# Hotel Room Safe Box

Model: E2042H

- Product Size: W:420xD:370xH:200mm
- Thickness-Body/Door:  $\Phi 1.5/\Phi 5$ mm
- Solid, arc-welded heavy-gauge steel construction. Orange peel powder coating finish or sand texture powder coating finish.
- 18mm Solid Steel Bolt for Maximum Security and Durability.
- Pre-Drilled Mounting Holes
- Powered by 4xAA. Automatic Low Battery Level Alert
- LED Display Screen
- User Management: 3-6 Digit Guest Code
- Hotel Management: 6 Digit Override Master Code/Override Mechanical Key
- 5 Minutes Freeze System in Case of Wrong Code for 3 Times
- Back Up Power Supply

## SOLID STEEL BOLT - DIFFERENT FABRICS

- 18mm solid steel bolt for maximum security and durability.
- Solid, arc-welded heavy-gauge steel construction. Orange peel powder coating finish or sand texture powder coating finish.



## CIPHER DISK

- LED display screen
- User management: 3-6 digit guest code.
- 5 minutes freeze system in case of wrong code for 3 times.
- Hotel management: 6 digit override master code/override mechanical key.



## LARGE CAPACITY

- Powered by 4 x AA. Automatic low battery level alert.



Jewelry



Important Documents



SLR Camera



Cash



Electronics



## Hotel Room Safe Box

Model: E2042MJ

- Product Size: W:420xD:370xH:200mm
- Thickness-Body/Door:  $\Phi$ 1.5/ $\Phi$ 5mm
- Solid, arc-welded heavy-gauge steel construction. Powder coating finish.
- 18mm Solid Steel Bolt for Maximum Security and Durability.
- Pre-Drilled Mounting Holes
- Powered by 4xAA. Automatic Low Battery Level Alert
- LED Display Screen
- 3-6 Digit User Code
- 6 Digit Master Code and Universal Mechanical Key
- 5 Minutes Freeze System in Case of Wrong Code for 4 Times.
- Audit Trail (1000 Records)

### Password Unlock

#### EMERGENCY KEY

The panel will be automatically locked if entered password incorrectly 3 times



### Small Size, Large Space

Special for Hotel



### Intelligent CNC Panel

Special for Hotel



### Laser Cutting, Steel Materials

No welding seam technology, improve anti-mite performance, precise and reliable.



### Built-In Power Unit

Freeze system in case of wrong code for 3 times, meanwhile password hiding function for option.



### Orange Peel Steel Plate

Special for Hotel





## Hotel Room Safe Box

Model: E2042V

- Product Size: W:420xD:370xH:200mm
- Thickness-Body/Door:  $\Phi$ 1.5/ $\Phi$ 5mm
- Solid, arc-welded heavy-gauge steel construction. Orange peel powder coating finish or Sand texture powder coating finish.
- 18mm Solid Steel Bolt for Maximum Security and Durability.
- Pre-Drilled Mounting Holes
- Powered by 4xAA. Automatic Low Battery Level Alert
- LED Display Screen (Blue Light)
- User Management: 3-6 Digit Guest Code
- Hotel Management: 6 Digit Override Master Code/Override Mechanical Key
- 5 Minutes Freeze System in Case of Wrong Code for 3 Times.
- Back Up Power Supply
- With Backlit Keypad



## Hotel Room Safe Box

Model: E2042U

- Product Size: W:420xD:370xH:200mm
- Thickness-Body/Door:  $\Phi$ 1.5/ $\Phi$ 5mm
- Solid, arc-welded heavy-gauge steel construction. Powder coating finish.
- 18mm Solid Steel Bolt for Maximum Security and Durability.
- Pre-Drilled Mounting Holes
- Powered by 4xAA. Automatic Low Battery Level Alert
- LED Display Screen
- 3-6 Digit User Code
- 6 Digit Master Code and Universal Mechanical Key
- 5 Minutes Freeze System in Case of Wrong Code for 4 Times.
- Audit Trail (1000 Records)

### ELABORATE DESIGN, ORIGINALITY CRAFTSMANSHIP

Freeze system in case of wrong code for 4 times, meanwhile password hiding function for option



LED Display Screen



Electronic Key Panel



Semi-Automatic Electronic Lock

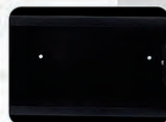

Wall-Mounted Screw Hole

### ELECTRONIC CODE LOCK CONCEALED KEY HOLE DESIGN Easy for hotel management



Digital Password



Hidden Key Hole



## Hotel Room Safe Box

Model: E2042BJ

- Product Size: W:420xD:370xH:200mm
- Thickness-Body/Door:  $\Phi$ 1.5/ $\Phi$ 5mm
- Solid, arc-welded heavy-gauge steel construction. Powder coating finish.
- 18mm Solid Steel Bolt for Maximum Security and Durability.
- Pre-Drilled Mounting Holes
- Powered by 4xAA. Automatic Low Battery Level Alert
- LED Display Screen
- 3-6 Digit User Code
- 6 Digit Master Code and Universal Mechanical Key
- 5 Minutes Freeze System in Case of Wrong Code for 4 Times.
- Audit Trail (1000 Records)

### ELABORATE DESIGN, ORIGINALITY CRAFTSMANSHIP

Freeze system in case of wrong code for 4 times, meanwhile password hiding function for option



LED Display Screen



Electronic Key Panel



Semi-Automatic Electronic Lock



Wall-Mounted Screw Hole



Inner Space

Wall Mounted



Battery Powered

Digital Display

## Hotel Room Safe Box

Model: E2042N

- Product Size: W:420xD:370xH:200mm
- Thickness-Body/Door:  $\Phi$ 1.5/ $\Phi$ 5mm
- Solid, arc-welded heavy-gauge steel construction. Orange peel powder coating finish or Sand texture powder coating finish.
- 18mm Solid Steel Bolt for Maximum Security and Durability.
- Pre-Drilled Mounting Holes
- Powered by 4xAA. Automatic Low Battery Level Alert
- LED Display Screen
- User Management: 3-6 Digit Guest Code
- Hotel Management: 6 Digit Override Master Code/Override Mechanical Key
- 5 Minutes Freeze System in Case of Wrong Code for 3 Times.
- With Backlit Keypad
- With Audit Trail Function, can Check Latest 1000 Records





## Hotel Room Safe Box

Model: E2042M

- Product Size: W:420xD:370xH:200mm
- Thickness-Body/Door:  $\Phi$ 1.5/ $\Phi$ 5mm
- Solid, arc-welded heavy-gauge steel construction. Orange peel powder coating finish or Sand texture powder coating finish.
- 18mm Solid Steel Bolt for Maximum Security and Durability.
- Pre-Drilled Mounting Holes
- Powered by 4xAA. Automatic Low Battery Level Alert
- LED Display Screen
- User Management: 3-6 Digit Guest Code
- Hotel Management: 6 Digit Override Master Code/Override Mechanical Key
- 5 Minutes Freeze System in Case of Wrong Code for 3 Times.
- Back Up Power Supply
- With Audit Trail Function, can Check Latest 1000 Records
- With Backlit Keypad

### SOLID STEEL BOLT - DIFFERENT FABRICS

- 18mm solid steel bolt for maximum security and durability.
- Solid, arc-welded heavy-gauge steel construction. Orange peel powder coating finish or sand texture powder coating finish.



### CIPHER DISK

- LED display screen
- Back up power supply
- With backlit keypad
- With audit trail function, can check latest 1000 records
- 5 minutes freeze system in case of wrong code for 3 times
- Hotel management: 6 digit override master code/override mechanical key

### LARGE CAPACITY

- Powered by 4 x AA. Automatic low battery level alert.



Jewelry



Important Documents



SLR Camera



Cash



Electronics

## Hotel Room Safe Box

Model: C2042

- Product Size: W:420xD:370xH:200mm
- Thickness-Body/Door:  $\Phi$ 1.5/ $\Phi$ 5mm
- Solid, arc-welded heavy-gauge steel construction. Orange peel powder coating finish or Sand texture powder coating finish.
- 18mm Solid Steel Bolt for Maximum Security and Durability.
- Pre-Drilled Mounting Holes
- Powered by 4xAA. Automatic Low Battery Level Alert
- LED Display Screen
- User Management: 3-6 Digit Guest Code/Magnetic Card
- Hotel Management: 6 Digit Master Code/Manage Card/Override Mechanical Key
- 5 Minutes Freeze System in Case of Wrong Code for 3 Times.
- With Credit Card Function, can use any Bank Card





## Top Open Hotel Room Safe Box

Model: DB1541

- Product Size: W:410xD:350xH:150mm
- Thickness-Body/Door:  $\Phi$ 1.5/ $\Phi$ 4mm
- Solid, arc-welded heavy-gauge steel construction. Orange peel powder coating finish or Sand texture powder coating finish.
- 18mm Solid Steel Bolt for Maximum Security and Durability.
- Pre-Drilled Mounting Holes
- Powered by 4xAA. Automatic Low Battery Level Alert
- LED Display Screen
- User Management: 3-6 Digit Guest Code
- Hotel Management: 6 Digit Override Master Code/Override Mechanical Key
- 5 Minutes Freeze System in Case of Wrong Code for 3 Times.



## Top Open Hotel Room Safe Box

Model: DB1541 15"

Product Size: W:450xD:350xH:150mm



## Top Open Hotel Room Safe Box

Model: D1541MJ

- Product Size: W:410xD:350xH:150mm
- Thickness-Body/Door:  $\Phi$ 1.5/ $\Phi$ 4mm
- Solid, arc-welded heavy-gauge steel construction. Powder coating finish.
- 18mm Solid Steel Bolt for Maximum Security and Durability.
- Pre-Drilled Mounting Holes
- Powered by 4xAA. Automatic Low Battery Level Alert
- LED Display Screen
- 3-6 Digit User Code
- 6 Digit Master Code and Universal Mechanical Key
- 5 Minutes Freeze System in Case of Wrong Code for 4 Times.
- Audit Trail (1000 Records)

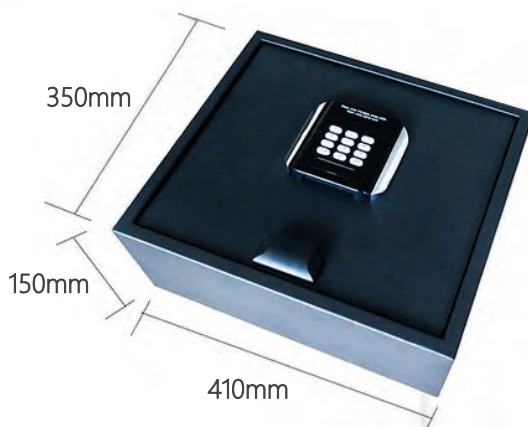

**ELECTRONIC CODE LOCK  
CONCEALED KEY HOLE DESIGN**

Easy for hotel management

Digital Password    Hidden Key Hole



## Top Open Hotel Room Safe Box

Model: D1541BJ

- Product Size:W:410xD:350xH:150mm
- Thickness-Body/Door:  $\Phi$ 1.5/ $\Phi$ 4mm
- Solid, arc-welded heavy-gauge steel construction. Powder coating finish.
- 18mm Solid Steel Bolt for Maximum Security and Durability.
- Pre-Drilled Mounting Holes
- Powered by 4xAA. Automatic Low Battery Level Alert
- LED Display Screen
- 3-6 Digit User Code
- 6 Digit Master Code and Universal Mechanical Key
- 5 Minutes Freeze System in Case of Wrong Code for 4 Times.
- Audit Trail (1000 Records)



## Top Open Hotel Room Safe Box

Model: D1541N

- Product Size:W:410xD:350xH:150mm
- Thickness-Body/Door:  $\Phi$ 1.5/ $\Phi$ 4mm
- Solid, arc-welded heavy-gauge steel construction. Orange Peel Powder Coating Finish or Sand Texture Powder Coating Finish.
- 18mm Solid Steel Bolt for Maximum Security and Durability.
- Pre-Drilled Mounting Holes
- Powered by 4xAA. Automatic Low Battery Level Alert
- LED Display Screen
- User Management: 3-6 Digit Guest Code
- Hotel Management: 6 Digit Override Master Code/Override Mechanical Key
- 5 Minutes Freeze System in Case of Wrong Code for 3 Times.
- Back Up Power Supply



## Top Open Hotel Room Safe Box

### Model: D1541LP

- Product Size:W:410xD:350xH:150mm
- Thickness-Body/Door: Φ1.5/Φ4mm
- Solid, arc-welded heavy-gauge steel construction. Orange Peel Powder Coating Finish or Sand Texture Powder Coating Finish.
- 18mm Solid Steel Bolt for Maximum Security and Durability.
- Pre-Drilled Mounting Holes
- Powered by 4xAA. Automatic Low Battery Level Alert
- LED Display Screen
- User Management: 3-6 Digit Guest Code
- Hotel Management: 6 Digit Override Master Code/Override Mechanical Key
- 5 Minutes Freeze System in Case of Wrong Code for 3 Times.
- With Audit Trail Function
- With Backlit Keypad



## Drawer Type Hotel Room Safe Box

### Model: CT-2038G

- Solid, arc-welded heavy-gauge steel construction. Orange peel powder coating finish.
- 18mm Solid Steel Bolt for Maximum Security and Durability.
- Pre-Drilled Mounting Holes.
- Powered by 4xAA. Automatic Low Battery Level Alert
- LED Display Screen
- 3-6 Digit Guest Code
- 6 Digit Override Master Code/Override Mechanical Key
- 5 Minutes Freeze System in Case of Wrong Code for 4 Times
- Audit Trail Function (100 Last Records, Device 1% Free)
- Inside LED Light Strip



## Drawer Type Hotel Room Safe Box

### Model: CT2048MJ

- Size: W:480xD:400xH:200mm
- Solid-Arc Welded Heavy-Gauge Steel Construction. Orange Peel Powder Coating Finish
- 18mm Solid Steel Bolt for Maximum Security and Durability.
- Pre-Drilled Mounting Holes
- Powered by 4xAA. Automatic Low Battery Level Alert
- LED Display Screen
- 3-6 Digit Guest Code
- 6 Digit Override Master Code/Override Mechanical Key
- 5 Minutes Freeze System in Case of Wrong Code for 4 Times.
- Audit Trail Function (100 Last Records, Device 1% Free)
- Inside LED Light Strip

